

PACi

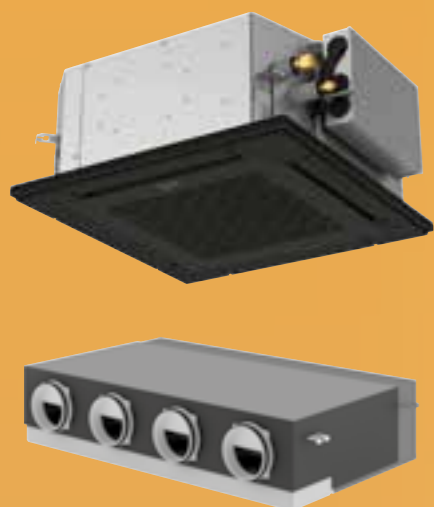

## Panasonic Commercial air to air

Panasonic has developed an impressive range of highly efficient Commercial Air Conditioners. This range confirms our commitment to the environment, with our highly efficient Inverter compressor technology to optimise performance.

### ABOUT

PACi NX Series. Compact yet mighty	→ 210
PACi NX Series. Highlighted features	→ 212
CONEX. Devices and apps	→ 214
Commercial Wi-Fi Adaptor	→ 215
Bringing nature's balance indoors	→ 216
<hr/>	
PACi NX 4 way 90x90 cassette - PU3	→ 218
PACi NX adaptive ducted unit - PF3	→ 220
BION air pollutant filter (optional)	→ 222
Multi zone duct unit	→ 224
PACi NX wall-mounted, 4 way 60x60 cassette and ceiling	→ 226
Big PACi NX Elite high static pressure hide-away - PE4	→ 228
Jet Air Stream	→ 230
<hr/>	
Commercial units range	→ 232
<hr/>	
PACi NX with Water Heat Exchanger for chilled and hot water production	→ 256
<hr/>	
Commercial twin, triple and double-twin systems	→ 260
<hr/>	
PACi NX – A versatile solution for comfort and specialised cooling applications	→ 266
PACi NX Elite can cool rooms down to 8 °C	→ 267
<hr/>	
R22 Renewal. Fast, easy to install and cost effective	→ 276
<hr/>	
Eurovent certified technical data	→ 288
<hr/>	
Features explained	→ 292

### PRODUCT SPECIFICATIONS

#### Commercial units range

Elite - Standard wall-mounted - PK4 · R32	→ 234
Elite - Standard 4 way 60x60 cassette - PY3 · R32	→ 238
Elite - Standard 4 way 90x90 cassette - PU3 · R32	→ 240
Elite - Standard ceiling - PT3 · R32	→ 244
Elite - Standard adaptive ducted unit - PF3 · R32	→ 248
Standard multi zone duct unit · R32	→ 252
Big PACi NX Elite high static pressure hide-away · R32	→ 254
PACi NX Jet Air Stream · R32	→ 255
PACi NX with Water Heat Exchanger	→ 259

#### Commercial twin, triple and double-twin systems → 262

Elite - Standard outdoor units · R32	→ 262
Compatible indoor units for multi combinations	→ 263
Simultaneous operation system combinations	→ 264
Refrigerant piping arrangements	→ 265

#### YKEA series for server rooms → 268

Wall-mounted Professional YKEA -25 °C · R32	→ 269
---	-------

#### Close Control P Series for small critical environments → 270

P Series - Perimetral · R32	→ 271
-----------------------------	-------

#### Ventilation

AHU connection kit PAH3M-1 for PACi NX	→ 272
Electric air curtain	→ 273
Air curtain with DX coil, connected to PACi NX systems	→ 274
Ceiling mounted air-e nanoe X Generator	→ 275

Accessories and control	→ 280
-------------------------	-------

## PACi NX Series. Compact yet mighty

A high-efficiency packaged air conditioning solution with advanced inverter compressor technology, delivering excellent energy savings.

Designed with innovative indoor air quality features and extensive connectivity options, ideal for shops, restaurants, offices, and residential applications.



### Product quality and safety.

All Panasonic Heating & Cooling Solutions undergo strict quality and safety testing before being released to the market. This rigorous process includes obtaining all required safety approvals to ensure every unit meets the highest industry standards and offers complete peace of mind.



**ECONOMIC AND ENERGY SAVING INNOVATION**

Lower electricity costs and a smarter solution for greater savings.



**INSTALLER-FOCUSED DESIGN**

Easy installation, simple refurbishment, and enhanced serviceability.



**SUSTAINABLE COMFORT INNOVATION**

A solution delivering comfort and improved IAQ with environmental responsibility.

### PACi NX Elite: Top-tier commercial air conditioning.

The PACi NX Elite range has been expanded to include the Big PACi NX Elite models 20,0-25,0 kW.

Outstanding performance at extreme ambient temperatures with very high energy efficiency both in heating and cooling. Fans, fan motors, compressors and heat exchangers engineered for maximum savings result in higher seasonal efficiencies, which ranks as one of the best in the industry, ensuring reduced CO<sub>2</sub> emissions, energy consumption and operating costs.

#### From 3,6 to 25,0 kW.

- Meeting all necessary approvals to ensure quality and safety
- Top class SEER: 8,9 A+++ / SCOP: 5,1 A+++ at 3,6 kW (in 90x90 cassette)
- A compact outdoor unit featuring a single fan across all the capacities
- Long piping allowance, maximum 100 m <sup>1)</sup>
- Wide operation range, up to 52 °C in cooling and down to -20 °C in heating
- Auto restart after power outage
- Twin, triple and double-twin connections
- Water Heat Exchanger <sup>2)</sup> and AHU connection compatibility

<sup>1)</sup> For models 10,0 - 25,0 kW. <sup>2)</sup> For models 20,0 - 20,5 kW.



### PACi NX Standard: For economy and value.

With high quality design and engineering, the PACi NX Standard are the perfect solutions for projects which demand quality on a limited budget. In addition, compact and lightweight design makes them ideal for installations with limited space including small commercial and residential applications. The slim and lightweight outdoor unit design enables installation even in very challenging locations.

#### From 2,5 to 14,0 kW.

- Extended range of outdoor units starting from 2,5 kW
- Great balance of system cost and performance
- Top class SEER / SCOP in the standard Inverter category  
SEER: 8,1 A++ / SCOP: 4,8 A++ at 3,6 kW (in 90x90 cassette)
- Variety of individual and central controllers which provides full flexibility
- Compact outdoor units, small footprint and lightweight
- Twin connection possible from 10,0 to 14,0 kW
- Operation range, up to 43 °C in cooling and down to -15 °C in heating



### Professional air conditioners with R32 refrigerant.

Panasonic recommends R32, with lower Global Warming Potential (GWP). Compared to R22 and R410A, R32 has a low potential impact on global warming.

Panasonic takes action in helping to protect the environment. In line with the European countries participating in the Montreal Protocol, protecting the ozone layer and preventing global warming, Panasonic is leading the switch to R32.

**R32**  
GWP REDUCED BY  
**75%**

# PACi NX Series. Highlighted features

The NX Series enables fast and easy refurbishment through its efficient 3-wire method and integrates nanoe™ X technology to deliver advanced indoor air quality performance. Its extensive IoT connectivity enables smart monitoring and optimized energy management.



## Increasing the efficiency.

An expanded air to air indoor unit line-up that provides high seasonal efficiency and year-round comfort, meeting a wide range of project requirements.

Energy class <sup>1)</sup> and seasonal efficiency value ( $\eta_{s,c} / \eta_{s,h}$ ) <sup>2)</sup>

Power (kW)	Wall-mounted - PK4		4 way cassette - PY3		4 way cassette - PU3		Ceiling - PT3		Adaptive ducted - PF3		Multi zone duct unit	Hide-away - PE4	Jet Air Stream
	Elite	Standard	Elite	Standard	Elite	Standard	Elite	Standard	Elite	Standard	Standard	Elite	Elite
2,5 kW	A++	A++	A++	A++									
3,6 kW	A++	A++	A++	A++	A+++	A++	A++	A++	A++	A+			
5,0 kW	A++	A+	A++	A+	A+++	A++	A++	A++	A++	A+			
6,0 kW	A++	A++	A++	A++	A+++	A++	A++	A++	A++	A+			
7,1 kW	A++	A+			A+++	A++	A++	A+	A++	A+	A++		
10,0 kW	A++	A++			A+++	A++	A++	A++	A++	A++	A++		
12,5 kW					304,3%	267,0%	278,4%	241,7%	281,7%	257,4%	254,5%		
					186,0%	157,0%	175,6%	147,4%	165,0%	142,6%	143,2%		
14,0 kW					286,6%	257,0%	263,3%	228,8%	275,9%	252,2%	251,8%		227%
					181,2%	152,2%	169,3%	145,3%	162,6%	140,6%	141,4%		155%
20,0 kW												237,8%	
												146,0%	
25,0 kW												213,0%	250%
												145,0%	155%

1) Energy label scale from A+++ to D for models below 12,0 kW (EU regulation 626/2011). 2)  $\eta_{s,c} / \eta_{s,h}$  values for models above 12,0 kW (EN 14825).

## PACi NX Series for absolute ease of refurbishment.

This series have been developed with 3 wire power and communication. It makes it simple and easy to replace old systems with 3 wire connections, which is prevalent in many systems.

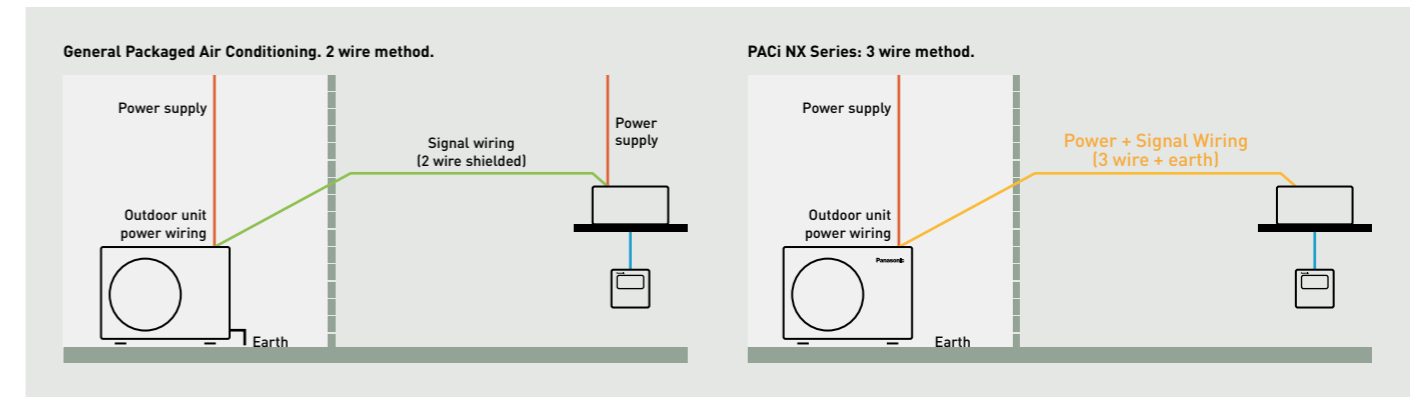

## CONEX with IoT integration

The wired remote controller CONEX is fully integrated with IoT solutions developed by Panasonic.

Detailed operation, maintenance setting and service operation are all possible with smartphone or tablet.

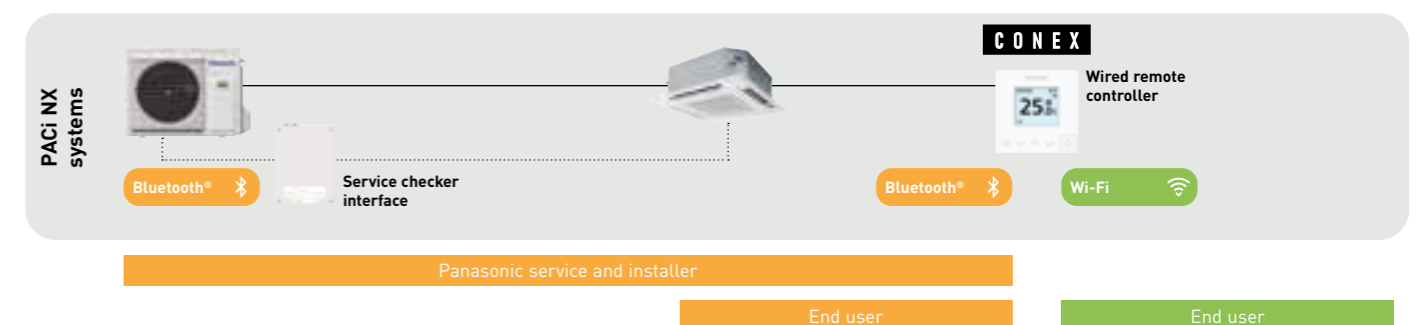

IoT solutions by Panasonic

- Panasonic H&C Diagnosis App <sup>1)</sup>**: Service checker function (detailed operation data etc...).
- Panasonic H&C Control App <sup>2)</sup>**: Detailed operation setting. Detailed maintenance setting.
- Comfort Cloud**: Panasonic Comfort Cloud App <sup>3)</sup>. Detailed operation setting. Remote operation via Wi-Fi.

1) A service checker interface is required when this app is used from outdoor location. Wired remote controller (CZ-RTC6WBL, CZ-RTC6BL, CZ-RTC6WBLW2 or CZ-RTC6BLW2) is required when this app is used from indoor location. Compatible with PZ3 and PZH3 outdoor units. 2) CZ-RTC6WBL, CZ-RTC6BL, CZ-RTC6WBLW2 or CZ-RTC6BLW2 required. 3) CZ-RTC6WBLW2 or CZ-RTC6BLW2 required.

## Let Panasonic take care of indoor air quality



Thanks to the nanoe™ X properties, several types of pollutants can be inhibited such as certain types of bacteria, viruses, mould, allergens, pollen and certain hazardous substances. This unique technology is equipped to provide better air quality whether residential or commercial.

## 7 effects of nanoe™ X – Panasonic unique technology.

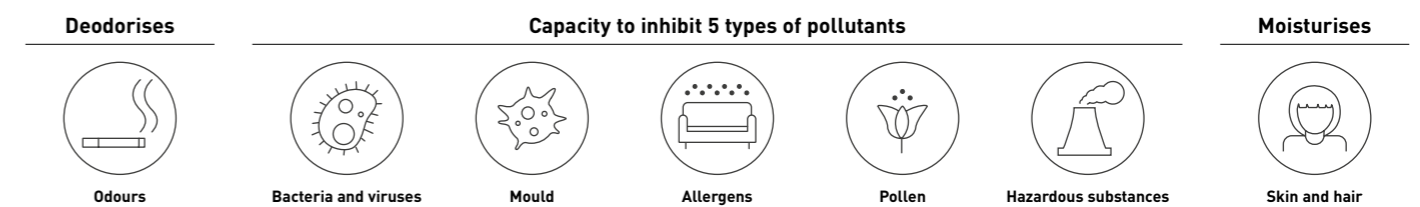

The nanoe™ X performance varies depending on the room size, environment and usage and it may take several hours to reach the full effect. nanoe™ X is not medical device, local regulations on building design and sanitary recommendations must be followed.

REFER TO PAGE 217 FOR MORE DETAILS AND VALIDATION DATA

# CONEX. Devices and apps

CONEX provides comfort and control for varying user needs. Accessible, flexible and scalable with different controllers and apps. Perfectly meeting requirements of modern controls for end user, installer and service.



## 1 Intuitive control with stylish design

- Simple operation at a glance
- Clean face with full flat and LCD display
- Compact body, only 86x86 mm

## 2 Control comfort with your smartphone

- Flexible control options with IoT integration
- Panasonic H&C Control App for daily remote control operation
- Panasonic Comfort Cloud App for remote operation 24/7/365

## 3 Easy maintenance with service support app

- Quick and easy app set-up for system setting
- Panasonic H&C Diagnosis App enables the user to obtain detailed system operation data

\*The use of apps depends on the remote controller model.

### CONEX with IoT integration

The wired remote controller CONEX is fully integrated with IoT solutions developed by Panasonic. Detailed operation, maintenance setting and service operation are all possible with smartphone or tablet.

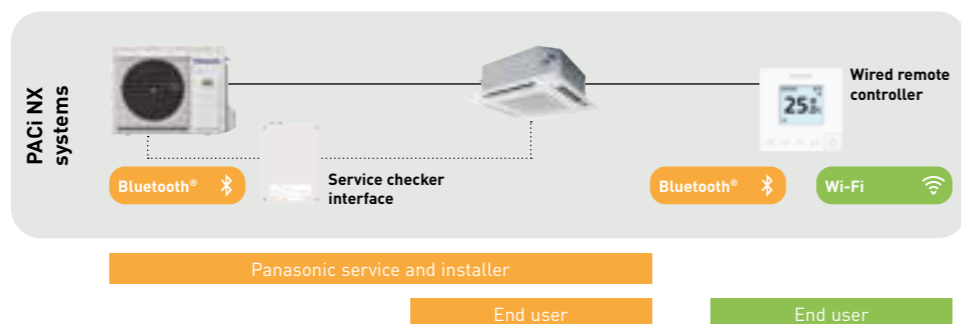

1) A service checker interface is required when this app is used from outdoor location. Wired remote controller (CZ-RTC6WBL, CZ-RTC6SBL, CZ-RTC6BWLW2 or CZ-RTC6BLW2) is required when this app is used from indoor location. Compatible with PZ3 and PZH3 outdoor units. 2) CZ-RTC6WBL, CZ-RTC6BL, CZ-RTC6BWLW2 or CZ-RTC6BLW2 required. 3) CZ-RTC6WBLW2 or CZ-RTC6BLW2 required.

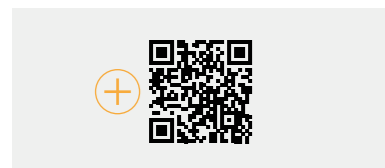

**IoT solutions by Panasonic**

**Panasonic H&C Diagnosis App**<sup>1)</sup>  
Service checker function (detailed operation data etc...).

**Panasonic H&C Control App**<sup>2)</sup>  
Detailed operation setting. Detailed maintenance setting.

**Panasonic Comfort Cloud App**<sup>3)</sup>  
Detailed operation setting. Remote operation via Wi-Fi.

White model	CZ-RTC6W	CZ-RTC6WBL	CZ-RTC6WBLW2
Black model	CZ-RTC6	CZ-RTC6BL	CZ-RTC6BLW2
Wired connection compatible with	PACi NX and ECOi	PACi NX and ECOi	PACi NX and ECOi <sup>1)</sup>
Wireless functions	No wireless capability	Bluetooth®	Bluetooth® + Wi-Fi
<b>App compatibility</b>			
Panasonic Comfort Cloud App	—	—	✓
Panasonic H&C Control App	—	PACi NX and ECOi	✓ PACi NX only
Panasonic H&C Diagnosis App <sup>2)</sup>	—	✓ PACi NX only <sup>3)</sup>	✓ PACi NX only <sup>3)</sup>
Outdoor unit settings (remote controller connected to indoor unit)	✓ PACi NX only <sup>3)</sup>	✓ PACi NX only <sup>3)</sup>	✓ PACi NX only <sup>3)</sup>

1) Available with ECOi indoor unit types MY3, MF3, MM2, and MK3. 2) Compatible with U-71/100/125/140PZH3E5/8 and U-100/125/140PZ3E5/8. 3) When connected to PACi NX indoor and outdoor unit combination.

# Commercial Wi-Fi Adaptor

Panasonic CZ-CAPWFC2 interface adaptor, allows connection of one or a group of indoor units to Panasonic Comfort Cloud App, which provides control, monitoring, scheduling, and error alerts.



## Advanced smartphone control.

Control PACi NX and ECOi indoor units with your smartphone whenever and wherever you are, by using Panasonic Comfort Cloud App and Commercial Wi-Fi Adaptor. This scalable solution is ideal for one system, one site or multiple locations. Coupling the adaptor with the already feature rich systems, makes it an ideal solution for residential and commercial applications.

### 1 From 1 to 200 units

User can control up to 10 different sites, with up to 20 units / groups per site. Additionally, one adaptor can be connected to 1 indoor or to a group of up to 8 indoors.

### 2 Voice control compatible

Registering the unit to Panasonic Comfort Cloud App makes it compatible with the most popular voice assistants.

### 3 Multi user

The Panasonic Comfort Cloud App allows multi-user access control, whilst allowing user restriction to specific units.

### 4 Easy scheduling

Complex weekly scheduling made simple. Not only for one unit, but across multiple sites, and from a smartphone.

### 5 Energy monitor

See the estimated power consumption and compare with other periods, to see how energy consumption can be further reduced. Check list of units that provides consumption\*.

\*Function available depending on the model.

### 6 Error codes

Error code notification through the App, provides early notification and allows for faster repair.

## Connection diagram

Commercial Wi-Fi Adaptor wiring length is 1,9 m and connects to indoor unit via T10 connector and R1/R2 terminal connectors.

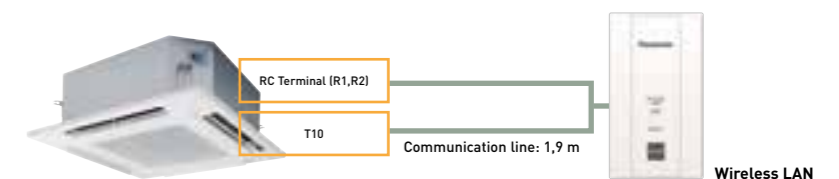

Input Voltage	12 V DC (supplied from T10 connector)
Power Consumption	Maximum 2,4 W
Size (HxWxD)	120 x 70 x 25 mm
Weight	190 g (including communications lines)
Interface	1 x Wireless LAN
Wireless LAN Standard	IEEE 802,11 b/g/n

Frequency Range	2,4 GHz band
Operating range	0 ~ 55 °C, 20 ~ 80 RH%
Connectable indoor unit	1 unit
Length of communication line	1,9 m (included)

## Panasonic Comfort Cloud App

### Download free app.

Other hardware requirements: Wi-Fi internet connection (not included) and Smartphone or tablet with internet access. The Panasonic Cloud Server is fully managed and operated by Panasonic. \*The app screen is for illustration purposes only. The actual screen may differ.



# Bringing nature's balance indoors



## nanoe™ X, technology with the benefits of hydroxyl radicals.

Abundant in nature, hydroxyl radicals (also known as OH radicals) have the capacity to inhibit pollutants, viruses, and bacteria to clean and deodorise. nanoe™ X technology can bring these incredible benefits indoors so that hard surfaces, soft furnishings, and the indoor environment can be a cleaner and more pleasant place to be, whether at home, work, or visiting hotels, shops and restaurants etc.



### What is unique about nanoe™ X?

Effective on fabrics and surfaces.

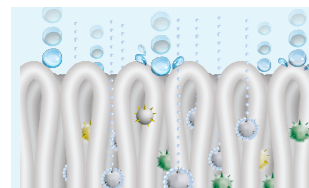

1 | At one billionth of a metre, nanoe™ X is much smaller than steam and can deeply penetrate cloth fabrics to deodorise.

Longer lifespan.



2 | Contained in tiny water particles, nanoe™ X has a long lifespan, which is about 600 seconds, to spread easily around the room.

Huge quantity.



3 | nanoe X Generator Mark 3 produces 48 trillion hydroxyl radicals per second. Greater amounts of hydroxyl radicals contained in nanoe™ X lead to higher performance on inhibition of pollutants.

Maintenance-free.



4 | No service and maintenance required. nanoe™ X is a filter free solution that does not require maintenance, as its atomisation electrode is enveloped with water during its generation process and it is made with Titanium.

### 7 effects of nanoe™ X – Panasonic unique technology

Deodorises



Odours

Capacity to inhibit 5 types of pollutants

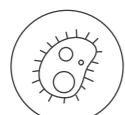

Bacteria and viruses

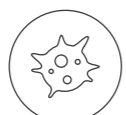

Mould



Allergens



Pollen



Hazardous substances



Skin and hair

\*Refer to <https://aircon.panasonic.eu> for more details and validation data.

### First nanoe™ device was developed by Panasonic in 2003

Generator: nanoe™	Generator: nanoe™ X		
2003	Mark 1 - 2016	Mark 2 - 2019	Mark 3 - 2022
480 billion hydroxyl radicals/sec	4,8 trillion hydroxyl radicals/sec	9,6 trillion hydroxyl radicals/sec	48 trillion hydroxyl radicals/sec
Ion particle structure	10x times	20x times	100x times
Hydroxyl radicals			

### nanoe™ X, internationally-validated technology in testing facilities.

The effectiveness of nanoe™ X technology has been tested by 3rd party laboratories in Germany, France, Denmark, Japan and China.

The nanoe™ X performance varies depending on the room size, environment and usage and it may take several hours to reach the full effect. nanoe™ X is not medical device, local regulations on building design and sanitary recommendations must be followed. Test results conducted under controlled laboratory conditions. Performance of nanoe™ X might differ in real life environment.

	Tested contents	Generator	Result	Capacity	Time	Testing organisation	Report No.	
Airborne	Virus	Influenza (H1N1)	Mark 2	98,3% inhibited	30 m <sup>3</sup>	1,5 h	China Electronic Product Reliability and Environmental Testing Research Institute	J2003WT8888-00889
		Bacteriophage ΦX174	Mark 1	99,2% inhibited	Approx. 25 m <sup>3</sup>	6 h	Kitasato Research Center for Environmental Science	24_0300_1
	Bacteria	Staphylococcus aureus	Mark 1	99,7% inhibited	Approx. 25 m <sup>3</sup>	4 h	Kitasato Research Center for Environmental Science	24_0301_1
Adhering	SARS-CoV-2	Mark 1	91,4% inhibited	6,7 m <sup>3</sup>	8 h	Texcell (France)	1140-01 C3	
		Mark 1	99,9% inhibited	45 L	2 h	Texcell (France)	1140-01 A1	
	Virus	Bacteriophage ΦX174	Mark 1	99,8% inhibited	Approx. 25 m <sup>3</sup>	8 h	Japan Food Research Laboratories	13001265005-01
		Xenotropic murine leukemia virus	Mark 1	99,999% inhibited	45 L	6 h	Charles River Biopharmaceutical Services GmbH	—
		Coxsackie virus (CA16)	Mark 2	99,9% inhibited	30 m <sup>3</sup>	4 h	China Electronic Product Reliability and Environmental Testing Research Institute	J2002WT8888-00439
		Bacteriophage	Mark 3	98,81% inhibited	Approx. 139,3 m <sup>3</sup>	4 h	SGS Inc	SHES210901902584
	MS2 Phage Virus	Mark 3	99,99% inhibited	Approx. 25 m <sup>3</sup>	2 h	Shokukanken, Inc.	227131N	
		Staphylococcus aureus	Mark 1	99,9% inhibited	20 m <sup>3</sup>	8 h	Danish Technological Institute	868988
	Pollen	Cedar pollen	Mark 3	99% inhibited	Approx. 24 m <sup>3</sup>	12 h	Panasonic Product Analysis Center	H21YA017-1
		Ambrosia pollen	Mark 1	99,4% inhibited	20 m <sup>3</sup>	8 h	Danish Technological Institute	868988
Odours	Cigarette smoke odour	Mark 1	Odour intensity reduced by 2,4 levels	Approx. 23 m <sup>3</sup>	0,2 h	Panasonic Product Analysis Center	4AA33-160615-N04	
		Mark 3	Odour intensity reduced 1,7 levels	Approx. 139,3 m <sup>3</sup>	0,5 h	SGS Inc	SHES210901902478	

### Meets the requirements of VDI 6022 and HACCP

Certified under VDI 6022, meeting one of the strictest hygiene requirements on the market for HVAC systems, and aligned with HACCP-based food-safety practices.



VDI 6022 – Part 5 <sup>1)</sup> Certification.

Avoidance of allergenic exposure. Inhibits a wide range of harmful bacteria, viruses, mould, pollen and allergens.



VDI 6022 – Part 1 <sup>1)</sup> & 1.1 <sup>2)</sup> Certification.

Ventilation and indoor-air quality. Panasonic nanoe™ X technology improving indoor air quality.



HACCP Food Safety Certified <sup>3)</sup> – Europe's first HVAC manufacturer.

1) Certification mark only valid for nanoe X Generator Mark 3. 2) Certification mark only valid for nanoe X Generator Mark 2 and Mark 3. 3) Applicable to PACi NX and ECOi indoor units equipped with nanoe X Generator Mark 3.

### nanoe™ X: improving protection 24/7.

Acts to clean your air, so that the indoor environment can be a cleaner and more pleasant place to be all day long. nanoe™ X works together with heating or cooling function when you are at home and can work independently when you are away. Give the air conditioning the strength to increase the protection at home with nanoe™ X technology and convenient control via the Panasonic Comfort Cloud App.

**Cleans the air even when there is no work activity.** Leave the nanoe™ X mode ON to inhibit certain pollutants and deodorize before start the work activity again.

**Improves your environment and better protects the products handled when you are or not at work.** Enjoy a cleaner comfortable space both when working indoors and simply when it comes to better protecting products in the cold room.

### Panasonic Heating & Cooling Solutions is incorporating nanoe™ technology in a wide range of equipment

	<b>Wall-mounted.</b> Built-in nanoe X Generator Mark 3.		<b>Ceiling.</b> Built-in nanoe X Generator Mark 2.
	<b>4 Way 60x60 cassette.</b> Built-in nanoe X Generator Mark 2.		<b>Adaptive ducted unit.</b> Built-in nanoe X Generator Mark 2.
	<b>4 Way 90x90 cassette.</b> Built-in nanoe X Generator Mark 1.		<b>High static pressure hide-away.</b> Built-in nanoe X Generator Mark 3.
	<b>Ceiling mounted air-e nanoe X Generator.</b> Built-in nanoe X Generator Mark 1.		

# PACi NX 4 way 90x90 cassette - PU3

These cassettes offer upgraded nanoe™ X and Econavi technologies to make the room air more comfortable and healthy and to increase the energy efficiency.



SEE PRODUCT SPECIFICATIONS

White and graphite black panels available, offering versatile options for commercial applications.



Standard panel, white (RAL9003). CZ-KPU3



Standard panel, graphite black (RAL9011). CZ-KPU3B

Econavi panel, white (RAL9003). CZ-KPU3A

### Always fresh and clean air with nanoe™ X

The 4 way 90x90 cassette with nanoe™ X, when tested, has shown to inhibit hazardous substances by 92%, when compared to natural reduction\*. In addition to the 7 effects of nanoe™ X, the indoor unit can also be cleaned with a short operation of nanoe™ X + dry mode.

\*Controllers (CZ-RTC5B, CZ-RTC6W/BL/BLW2 or CZ-RTC6/BL/BLW2) are required.

After cooling/drying operation, the inside of the indoor unit is automatically dried and nanoe™ X is activated to suppress mould growth.

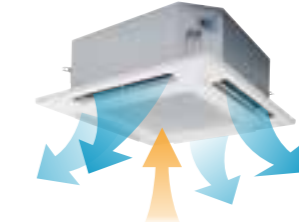

Operates the fan to discharge internal humidity.

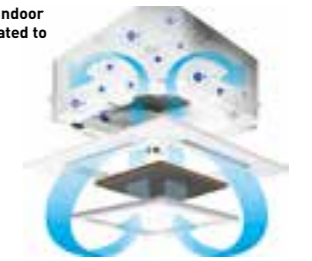

Operate the fan to circulate nanoe™ X internally.

### nanoe™ X effect against odour proven in large space

92% of hexadecane <sup>1)</sup> is inhibited after 8-hours exposure in room side 267 m<sup>2</sup>.

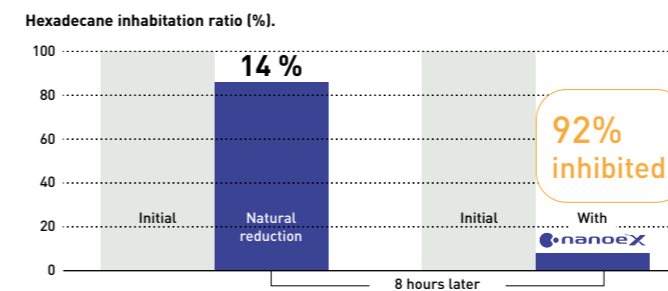

**Test ambient.**  
3rd party certification organization SIRIM <sup>2)</sup> conducted the performance experiment of 4 way cassette equipped with nanoe X Generator Mark 1 device in inhibiting hexadecane, a chemical contaminant.

<sup>1)</sup> Hexadecane is a hazardous substance contained in gasoline and diesel exhaust gas, and considered to be one cause of oil odour. <sup>2)</sup> SIRIM Berhad (SIRIM), a premier industrial research and technology organization in Malaysia, wholly-owned by the Ministry of Finance Incorporated.

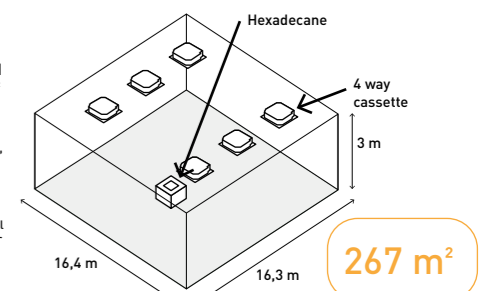

## 1 Improved indoor air quality with nanoe™ X and fresh air intake

- nanoe™ X technology equipped as standard for improved indoor air quality
- Internal cleaning function for the unit with nanoe™ X
- High external fresh air intake volume with optional kit (CZ-FDU3 + CZ-ATU2)

## 2 Superior energy efficiency and comfort

- High seasonal efficiency both in heating and cooling, maximum SEER: 8,9 A+++ / SCOP: 5,1 A+++\*
- Econavi: Intelligent sensors to increase energy savings and comfort
- Super Quiet operation down to 27 dB(A)

\*For 3,6 kW model.

## 3 Easy installation

- Light weight, easy piping and integrated drain pump for quick installation
- Wired remote controller CZ-RTC6WBL and CZ-RTC6BL allows easy system setting via Bluetooth®

### Optional Econavi intelligent sensor

Human activity sensor and floor temperature sensor can reduce waste energy, by optimising air conditioner operation.

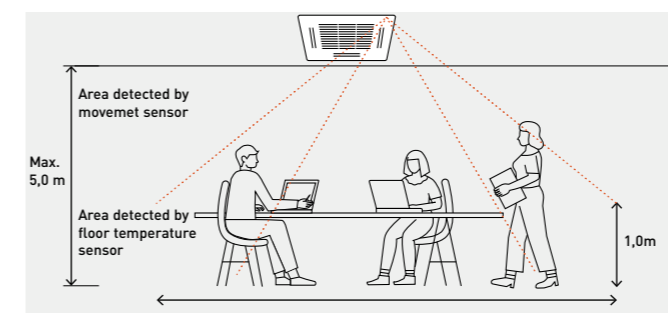

### Advanced Econavi functions.

2 sensors (movement and floor temperature) can provide a reduction in wasted energy by means of effective control. The floor temperature can be detected with a ceiling height of up to 5 m.

**Econavi exclusive panel. Optional (CZ-KPU3A)**

**Floor temperature sensor.** This sensor detects average floor temperature and operates circulation if floor temperature is low.

**Movement sensor.** This sensor detects the amount of human activity, and operates effectively.

Wired remote controller CZ-RTC5B, CZ-RTC6W/BL/BLW2 or CZ-RTC6/BL/BLW2 is required.

# PACi NX adaptive ducted unit - PF3

The adaptive ducted units provide better flexibility with both installation possibilities, horizontal and vertical. The powerful external static pressure, maximum 150 Pa.



SEE PRODUCT SPECIFICATIONS

**1 Highly flexible installation**  
2 installation possibilities (horizontal / vertical).

**2 High seasonal performance with slim body**  
Maximum SEER: 7,4 A++ <sup>1)</sup> / SCOP: 4,7 A++ <sup>2)</sup>.  
1) For 10,0 kW model. 2) For 7,1 kW model.

### 2 installation possibilities (horizontal / vertical)

Vertical installation is available. External static pressure 150 Pa, sufficient for remotely installing units away from the rooms.



### Selectable inlet air position

Inlet air position may be adjusted by means of a removable panel, to allow rear or bottom entry, depending on the duct installation.

**3 Comfort operation**  
· Super Quiet operation, minimum 22 dB(A)\*  
· Optimized IAQ solutions for different target objectives. nanoe™ X and the BION air pollutant filter (optional)

\*3,6 kW model and when operating with external static pressure 50 Pa in low fan mode.

### Improved drain pan design

Just one drain pan for both horizontal and vertical installations. No need to modify the unit.

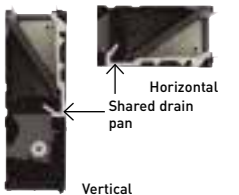

### Maximum efficiency

Energy class <sup>1)</sup> and seasonal efficiency value ( $\eta_{s,c} / \eta_{s,h}$ ) <sup>2)</sup>		3,6	5,0	6,0	7,1	10,0	12,5	14,0
Elite		A++	A++	A++	A++	A++	281,7%	275,9%
		A+	A+	A++	A++	A+	170,0%	171,0%
Standard		A+	A++	A++	A++	A++	257,4%	252,2%
		A+	A+	A++	A+	A	142,6%	140,6%

1) Energy label scale from A+++ to D for models below 12,0 kW (EU regulation 626/2011). 2)  $\eta_{s,c} / \eta_{s,h}$  values for models above 12,0 kW (EN 14825).

### Compact body

· Only 250 mm high  
· Light units from 25 to 39 kg

Conventional model	Adaptive ducted
33 kg	30 kg
290 mm	250 mm

### Adaptive ducted



### Better indoor air quality with nanoe™ X

The performance of nanoe™ X technology is maintained, even with 10 m long ducts\*. The effect of improved air quality is sufficient to allow for numerous duct shapes to fit the application.

\*Panasonic internal survey.

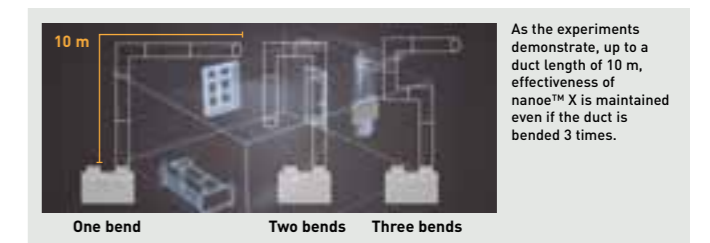

### nanoe™ X effect against odour proven in large space

In a room of 139 m<sup>2</sup>, tobacco odour is reduced by a factor of 0,7 when compared to natural reduction over a period of 2 hours.

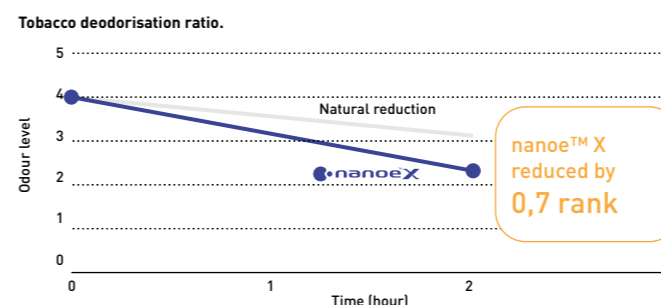

### Test ambient.

3rd party international testing institute KAKEN <sup>1)</sup> conducted the performance experiment of Adaptive ducted equipped with nanoe X Generator Mark 2 device removing tobacco odour.

<sup>1)</sup> KAKEN TEST CENTER General Incorporated Foundation in Japan, international testing institute.

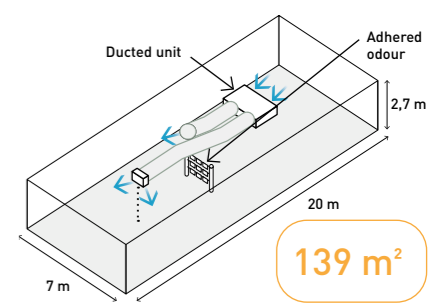

# BION air pollutant filter (optional)

Collaborating with BION, experts in filtration equipment, a new molecular filtration is available to improve indoor air quality.



**The efficiency of nitrogen dioxide (NO<sub>2</sub>) removal can reach 99,5%\***

\*Measured by ASTM6646 international standards. Efficiency reaches 99,5% within 4,8 seconds of contact time with the media bed (FAM filter). \*\*The performance varies depending on the room size, environment and usage and it may take several hours to reach the full effect. BION air pollutant filter is not medical device, local regulations on building design must be followed. Test results conducted under controlled laboratory conditions. Performance of BION air pollutant filter might differ in real life environment.

### BION air pollutant filter traps and reduces certain types of harmful pollutant gases, listed below

- Nitrogen oxides (NO<sub>x</sub>)
- Ozone (O<sub>3</sub>)
- Sulfur dioxide (SO<sub>2</sub>)
- Formaldehyde (HCHO)
- Volatile organic compounds (VOCs)

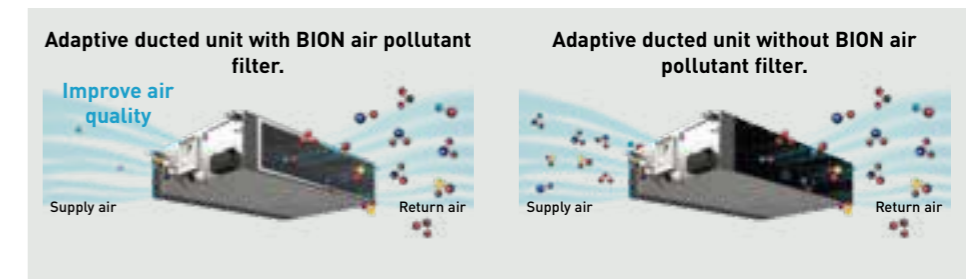

### The BION air pollutant filter is an ideal solution for improving indoor air quality in urban areas.

#### Air pollution in urban areas in Europe

It is reported that in 2021, a significant portion of the Europe's urban population has been exposed to high levels of key air pollutants\*.

- 75% of the urban population was exposed to NO<sub>2</sub> concentrations above 10 µg/m<sup>3</sup>
- 94% were exposed to concentrations of O<sub>3</sub> above 60 µg/m<sup>3</sup>

\*The "Europe's Air Quality Status 2023" report (EEA, 2023) assesses levels of air pollutants measured in ambient air across Europe (> 2000 locations) for the years 2021 and 2022. It compares them against both EU standards as set out in the Ambient Air Quality Directives and the 2021 WHO Air Quality Guidelines.

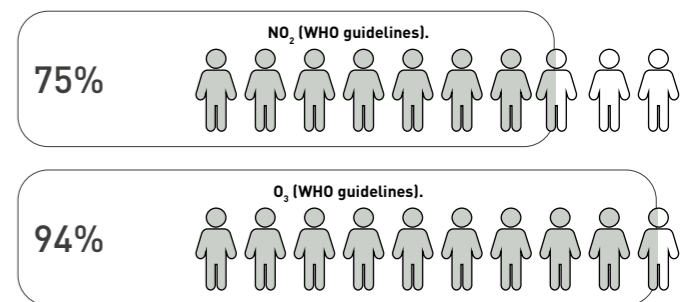

Share of the Europe's urban population exposed to air pollutant concentrations above EU standards and WHO guidelines in 2021, as referenced in the EEA 2023.

#### Why outdoor air pollution matters to IAQ?

Poor indoor air quality is associated with outdoor air pollutants such as car exhaust and factory fumes, and the two are closely linked. A significant portion of human exposure to air pollution occurs when they are indoors.



#### Different objectives, different IAQ solutions

In today's world, we are concerned about wellbeing and the air we breathe. And technology exists to ensure improved indoor air quality. With the introduction of the BION air pollutant filter, Panasonic offers IAQ solutions optimized for various target objectives.

IAQ Solution	nanoe™ X	BION air pollutant filter
<b>Objectives</b>	Inhibit particles such as pollutants, certain types of viruses, and bacteria to clean and deodorise	Inhibit gases such as nitrogen oxides (NO <sub>x</sub> ), ozone (O <sub>3</sub> ), sulfur dioxide (SO <sub>2</sub> ), formaldehyde (HCHO) and volatile organic compounds (VOCs)
<b>Technology</b>	Hydroxyl radicals contained in water	Molecular filtration
<b>Filtering mechanism</b>	Physical capture of particles	Adsorption and absorption
<b>Availability</b>	Built into all air-to-air indoor units as a standard	Optional accessory for the adaptive ducted unit (PF3/MF3)

<b>BION air pollutant filter*</b>	PAW-APF800F	PAW-APF1000F	PAW-APF1400F
<b>Compatible adaptive ducted unit</b>	S-3650PF3E	S-6071PF3E	S-1014PF3E

\*The filter cartridge and filter casing are included in the package.

# New multi zone duct unit

Zoned air flow. Maximum comfort. Minimal energy.

The multi zone duct is an energy- and cost-saving solution. It enables independent temperature control for up to five zones and reduces both time and cost during zone duct installation.



**Intuitive wall controller**  
PCZ-EEB749



SEE PRODUCT SPECIFICATIONS

## Multi zone management – Energy saving solution

Independent temperature control per each zone can be controlled by a wall control.



\*Wall-mounted controller (PCZ-EEB749).

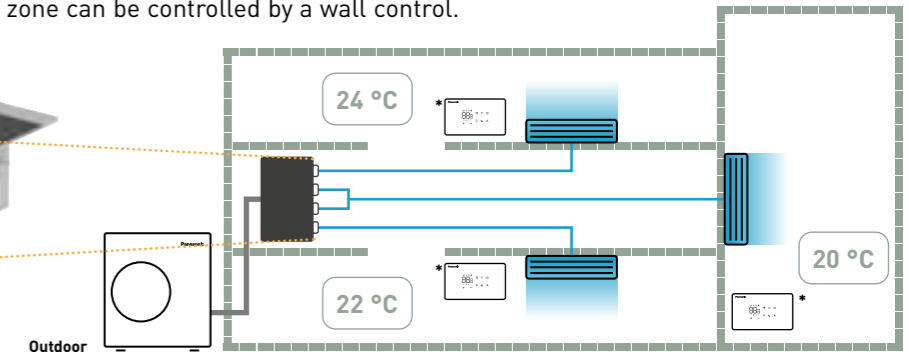

## High installation flexibility

- 2 installation possibilities (horizontal / vertical)
- Up to 5 zones design
- Single or multi-fan control by single wall control. It is possible to control several fans by a single wall control or a single signal in the case of the need to provide ample zone coverage or higher heating / cooling requirements

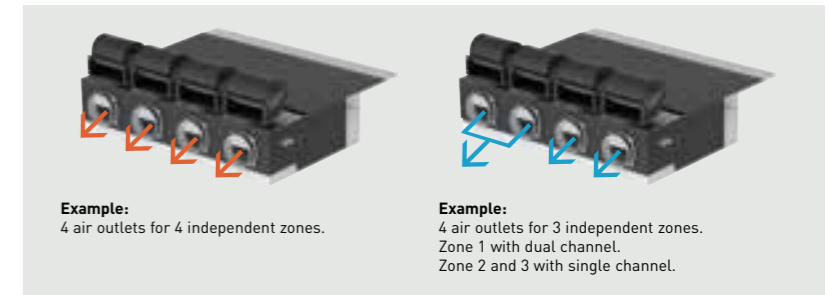

## Bypass duct free solution

Multi zone duct solution eliminates bypass ducts, offering independent fan control per zone for precise comfort and energy savings. It ensures optimized airflow, customizable temperature control, and lower power consumption compared to traditional systems. Ideal for scalable installations with superior efficiency and flexibility.

## Built-in Wi-Fi and Ethernet internet connection\*.

**1 |** One simple and quick internet connection for all the zones.

The multi-zone duct unit features a built-in Wi-Fi module with Ethernet port, providing rapid, one-time Wi-Fi configurations for all zones. The Wi-Fi module can be placed out of the unit for better Wi-Fi router signal coverage.

\*The Wi-Fi module must be disconnected when the unit is connected to Modbus.

**2 |** Comfort management anytime, anywhere with Aquarea Home app.



## Aquarea Home App

Download free app.

Other hardware requirements: Router and Internet (purchase and subscribe separately). Panasonic Cloud Server is designed, operated and managed by Panasonic.  
\*The app screen is for illustration purposes only. The actual screen may differ.



**EVERY SAVING. INDIVIDUAL TEMPERATURE CONTROL\***

**FLEXIBLE DESIGN. 4, 5 ZONES. HORIZONTAL / VERTICAL INSTALLATION**

**EASY ZONE CONTROL INSTALLATION. NO EXTERNAL CONTROL REQUIRED**

**BUILT-IN WI-FI CONTROL**

\*All zones will operate in the same mode.

## PACi NX wall-mounted, 4 way 60x60 cassette and ceiling

A new era of air conditioning solutions are here, with built-in nanoe™ X technology.

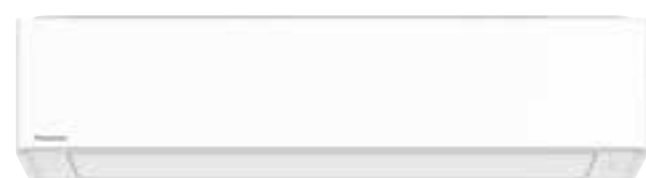

SEE PRODUCT SPECIFICATIONS

### PACi NX wall-mounted - PK4.

Equipped with the upgraded nanoe™ X (Generator Mark 3) for improved indoor air quality. It's modern, flat design with a stylish matte white finish complements any interior, while improved fan serviceability ensures effortless maintenance.

#### Modern design for any interior

Its modern, flat design with a stylish matte white finish suits any interior, perfect for commercial projects.

**Air distribution is automatically altered depending on the operational mode of the unit**

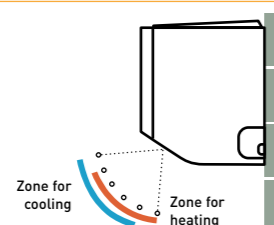

#### Piping outlet in six directions

Piping outlet is possible in six directions of; right, right rear, right bottom, left, left rear and left bottom, making the installation work more flexible.



#### Efficient installation with drain hose support holders and lock mechanism

##### Easy connection and disconnection of the drain hose.

Locking mechanism between the drain tray and hose ensures a tight connection during installation and easy dismantling.



##### Built-in support holders for secure spacing.

Holds the indoor unit against the wall, providing clear access for setting up the drain hose and piping.



SEE PRODUCT SPECIFICATIONS

### PACi NX 4 way 60x60 cassette - PY3.

The PY3 not only perfectly matches with 600 x 600 mm ceiling grids but also provides an additional benefit for better indoor quality, with nanoe™ X built-in.

#### Industry-leading energy efficiency

- Energy class A++\* with Elite outdoor range
- Energy class A++ with Standard outdoor range 2,5 kW model

\*Except for 6,0 kW.

#### Internal cleaning function

When cooling or dry operation stopped, internal drying and nanoe™ X circulation air flow is activated in order to suppress the mould proliferation inside the unit (air flow passage, fan, heat exchanger)\*.

\*Depending on the installation environment or operating hours, mould proliferation or inhabitation of mould growth will be changed.

#### Compact and stylish design

- Required ceiling depth of only 250 mm
- Exposed area is only 30 mm

#### Individual flap control

Better control of the air flow with 4 motors, providing individual flap control.

Perfect air distribution without direct air flow, to reduce the feeling of cold drafts.

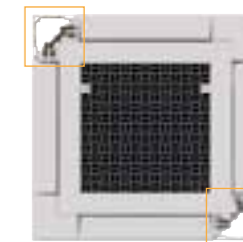

**White and graphite black panels available for the 4 way 60x60 cassette, offering versatile options for residential and light commercial applications.**



Panel, white (RAL9003).  
CZ-KPY4W



Panel, graphite black (RAL9011).  
CZ-KPY4B



SEE PRODUCT SPECIFICATIONS

### PACi NX ceiling - PT3.

Providing outstanding energy saving performance, comfort and long-distance air flow distribution, these units are perfect for retail stores and schools.

#### Comfortable, long-distance air flow distribution

The shape of the outlet has been optimised to provide long-distance air flow distribution. Even in long rooms, air flow reaches every corner for exceptionally comfortable air conditioning.

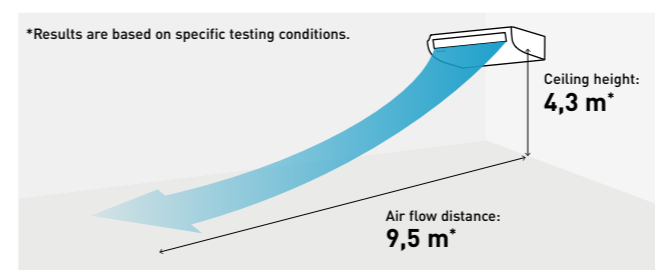

\*Results are based on specific testing conditions.

#### Compact looking, stylish, one-motion design

With its streamlined, one-motion form, the unit looks thin and compact when installed for a neat appearance in any room. When not operating, the louver closes to provide an elegant look while also keeping the unit clean.

#### Energy saving technology delivering top-class efficiency

Optimisation of the shape of the casing and fan assures bigger air flow and higher efficiency. Energy saving performance is top class in the industry. Thanks to new DC fan motor and large diagonal air flow fan.

# Big PACi NX Elite high static pressure hide-away 20,0-25,0 kW - PE4

The split-able indoor unit design facilitates easy piping work. nanoe™ X technology equipped as standard for improved indoor air quality.



SEE PRODUCT SPECIFICATIONS +

**1 Compact and light indoor body**  
Compact and light indoor body, keeping the high-efficiency, has a split-able design for easy installation within a limited narrow space. Plus ease of maintenance due to the simplified disassembly design.

**2 Easy pipe work with split-able hide-away indoor design**  
Heat exchanger and fan elements (fan + casing) can be separated during installation. The hide-away indoor unit is easily reassembled and will fit through a narrow space.

**3 High external static pressure, maximum 200 Pa\* setting**  
A high static pressure enables the use of long ducts for installation in a wide range of spaces.  
\*For model S-250PE4E.

**4 Comfort operation**  
· nanoe™ X as standard for improved indoor air quality  
· Smartphone control-ready with the Panasonic Comfort Cloud App <sup>1)</sup>  
1) Panasonic Wi-Fi Adaptor CZ-CAPWFC2 is required.

### Improved indoor air quality with nanoe™ X

The nanoe™ X technology is now available for the Big PACi NX Elite range from 20,0-25,0 kW. The PE4 model is equipped with Generator Mark 3, generating 48 trillion hydroxyl radicals/sec, specifically designed to accommodate long duct piping applications.

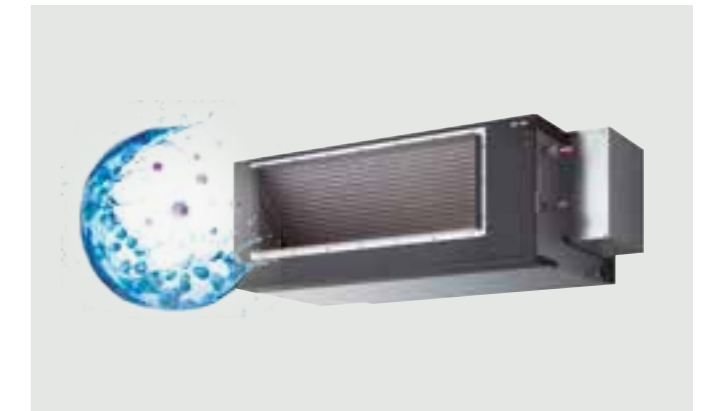

### Maximum 200 Pa\* static pressure setting

A high static pressure enables the use of long ducts for installation in a wide range of spaces.

**3-step static pressure set up.**  
Selectable of static pressure modes can change 200 Pa / 130 Pa / 75 Pa for extra installation flexibility.

\*For model S-250PE4E.



### Easy installation with light components

Indoor unit can easily be split into 3 components, the heaviest of which weighs only 48 kg.

**Dimension of each component (lightweight design for easy disassembly).**

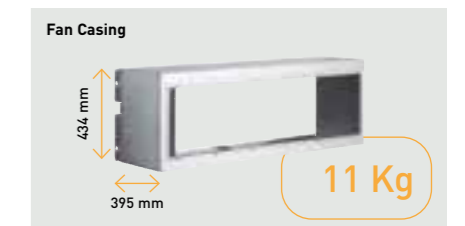
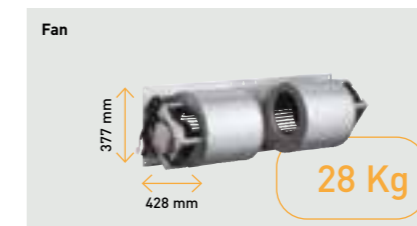
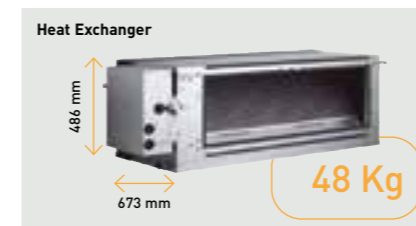

The weight is for S-250PE4E model.

# Jet Air Stream

Large spaces are often heated with boilers and unit heaters, which are inefficient, noisy, complex, and expensive fossil fuel systems that rarely offer summer cooling integration. The Jet Air Stream provides an efficient and sustainable solution for year-round heating and cooling in large spaces. It ensures optimal user comfort, a quiet environment, and is much easier to install than other systems.



The Jet Air Stream for the large spaces that require high air distribution, such as gymnasiums, production areas and warehouses.

SEE PRODUCT SPECIFICATIONS

## High air distribution for large spaces

High air volume with a long air flow distance of up to 30 m ensures optimal comfort for large spaces like warehouses and gyms.

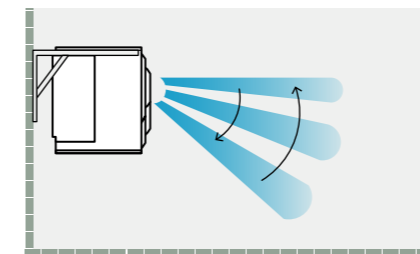
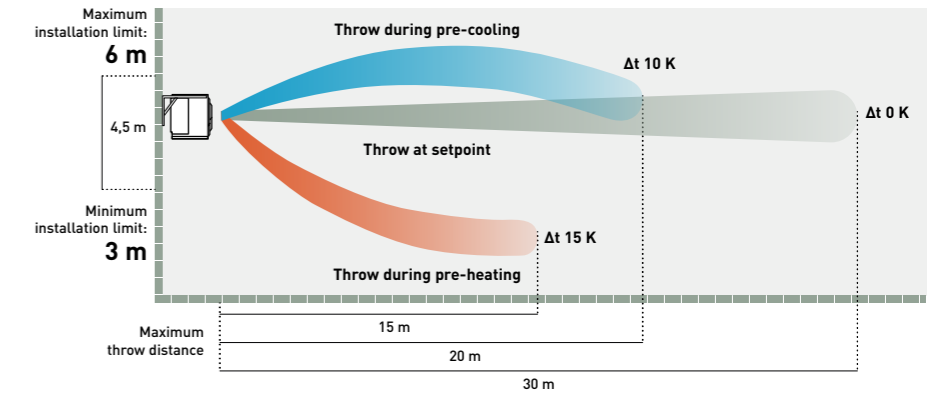

## Smart Jet - self-directing nozzles

Jet Air Stream Smart models ensure optimal comfort by preventing heat loss. Nozzle movements adapt dynamically to incoming air temperature, preventing stratification and maintaining an ideal temperature exclusively in the occupied area.

## Jet Air Stream operation

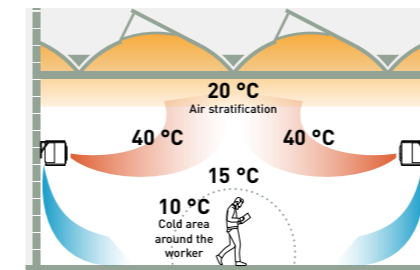

**Existing solution in heating.** Air stratification occurs when warm air from the heating system rises to the top of the room, while cold air stays at the bottom. This is due to warm air being lighter and rising, and cooler air being denser and staying low.

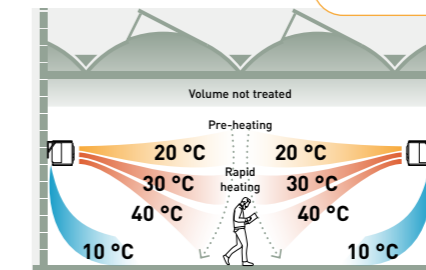

**Jet Air Stream operation in heating.**  
**Pre-heating:** Upon start-up, the Jet Air Stream Smart directs the nozzles horizontally, preventing not-yet-warm air from blowing on people.  
**Rapid heating:** Once the air reaches the ideal temperature, power is maximised and the nozzles point downward, ensuring rapid heating of the occupied area.

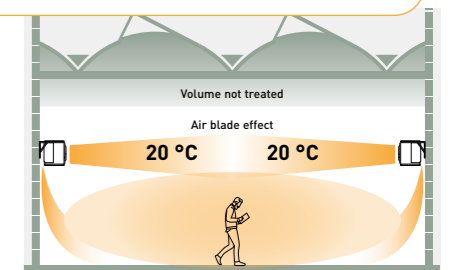

**Jet Air Stream operation in heating.** Maintenance with air blade effect: Jet Air Stream Smart adjusts power once the desired temperature is reached. This aligns nozzles horizontally, creating an 'air blade' as a thermal barrier to optimise heat distribution and prevent upward dispersion.

In cooling mode, the nozzle operation logic is inverted until the setpoint is reached

Type	Jet Air Stream Smart		Jet Air Stream Standard		Jet Air Stream Ducted	
Air flow	m <sup>3</sup> /h	2500 m <sup>3</sup> /h	5000 m <sup>3</sup> /h	2500 m <sup>3</sup> /h	5000 m <sup>3</sup> /h	2500 m <sup>3</sup> /h
Model		P-VTVF140MC5A-PE	P-VTVF250MC5A-PE	P-VTVF140NC5A-PE	P-VTVF250NC5A-PE	P-VTVF140PC5A-PE
Image		Smart Jet - self-directing nozzles		Manual nozzles		Ducted front panel

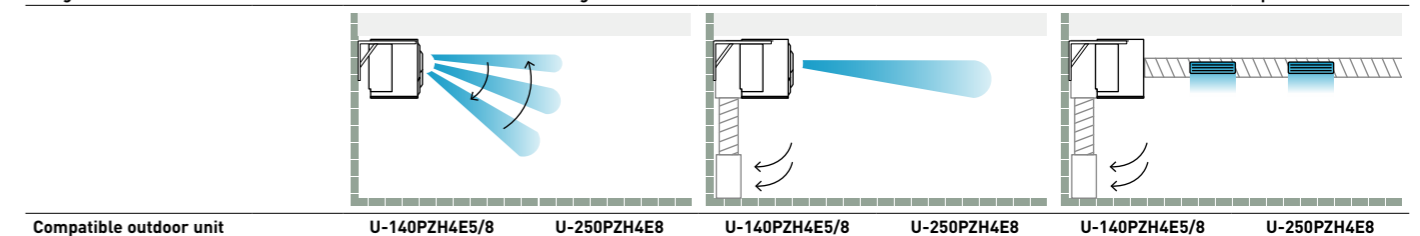

Compatible outdoor unit: U-140PZH4E5/8, U-250PZH4E8, U-140PZH4E5/8, U-250PZH4E8, U-140PZH4E5/8, U-250PZH4E8

**EFFICIENT HEATING AND COOLING**











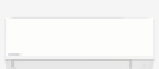
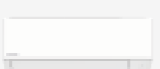
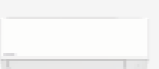
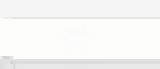
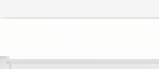
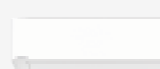
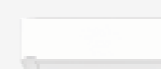

































**LONG AIR DISTRIBUTION**

**SMART JET - SELF-DIRECTING NOZZLES**

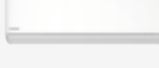
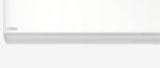
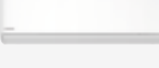
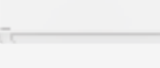
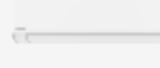
**QUIET OPERATION**

# Commercial units range

OPTIONAL UNITS ON VENTILATION SECTION 

Page	Indoor units	2,5 kW	3,6 kW	4,5 kW <sup>1)</sup>	5,0 kW	6,0 kW	7,1 kW	10,0 kW	12,5 kW	14,0 kW	20,0 kW	25,0 kW
P. 234	<b>PACi NX wall-mounted · R32</b>	 S-2545PK4E	 S-2545PK4E	 S-2545PK4E	 S-5010PK4E	 S-5010PK4E	 S-5010PK4E	 S-5010PK4E				
P. 238	<b>PACi NX 4 way 60x60 cassette · R32</b>	 S-25PY3E	 S-36PY3E	 S-50PY3E	 S-60PY3E						A new panel in graphite black (RAL9011) is available. 	
P. 240	<b>PACi NX 4 way 90x90 cassette · R32</b>		 S-3650PU3E	 S-3650PU3E	 S-3650PU3E	 S-6071PU3E	 S-6071PU3E	 S-1014PU3E	 S-1014PU3E	 S-1014PU3E	A panel in graphite black (RAL9011) is available. 	
P. 244	<b>PACi NX ceiling · R32</b>		 S-3650PT3E	 S-3650PT3E	 S-3650PT3E	 S-6071PT3E	 S-6071PT3E	 S-1014PT3E	 S-1014PT3E	 S-1014PT3E		
P. 248	<b>PACi NX adaptive ducted · R32</b>		 S-3650PF3E	 S-3650PF3E	 S-3650PF3E	 S-6071PF3E	 S-6071PF3E	 S-1014PF3E	 S-1014PF3E	 S-1014PF3E		
P. 252	<b>NEW! PACi NX multi zone duct · R32</b>						 S-7110PQ41E	 S-7110PQ41E	 S-1014PQ51E	 S-1014PQ51E		
P. 254	<b>Big PACi NX high static pressure hide-away 20-25 kW · R32</b>										 S-200PE4E	 S-250PE4E
P. 255	<b>NEW! PACi NX Jet Air Stream · R32</b>								 P-VTVF140MC5A-PE / P-VTVF140NC5A-PE / P-VTVF140PC5A-PE	 P-VTVF250MC5A-PE / P-VTVF250NC5A-PE / P-VTVF250PC5A-PE		
P. 269	<b>Wall-mounted Professional YKEA · R32 <sup>2)</sup></b>	 CS-Z25YKEA-1	 CS-Z35YKEA-1	 CS-Z42YKEA-1	 CS-Z50YKEA-1		 CS-Z71YKEA-1					
P. 271	<b>NEW! P Series – Perimetral · R32</b>						 T-UPZ/OPZ 0071	 T-UPZ/OPZ 0111	 T-UPZ/OPZ 0121	 T-UPZ/OPZ 0141		 T-UPZ/OPZ 0211

Outdoor units	2,5 kW	3,6 kW	5,0 kW	6,0 kW	7,1 kW	10,0 kW	12,5 kW	14,0 kW	20,0 kW	25,0 kW
<b>PACi NX Elite · R32</b> <b>Big PACi NX (20,0-25,0 kW) · R32</b>		 U-36PZH3E5	 U-50PZH3E5	 U-60PZH3E5	 U-71PZH4E5 / U-71PZH4E8	 U-100PZH4E5 / U-100PZH4E8	 U-125PZH4E5 / U-125PZH4E8	 U-140PZH4E5 / U-140PZH4E8	 U-200PZH4E8	 U-250PZH4E8
<b>PACi NX Standard · R32</b>	 U-25PZ3E5	 U-36PZ3E5	 U-50PZ3E5	 U-60PZ3E5A	 U-71PZ3E5A	 U-100PZ3E5 / U-100PZ3E8	 U-125PZ3E5 / U-125PZ3E8	 U-140PZ3E5 / U-140PZ3E8		

<sup>1)</sup> The 4,5 kW indoor capacity options are only available only for twin, triple and double-twin combinations. <sup>2)</sup> Not compatible with PACi NX outdoors and accessories. Domestic range sales conditions may apply. Check with your sales representative. \*U-\_\_E5 Single phase / U-\_\_E8 Three phase.

## PACi NX Series Elite wall-mounted - PK4 - R32

The wall-mounted units with stylish matt color can be offered for many applications such as studios, gyms, high ceiling areas and even computer server rooms. The compact design and flat face ensure discreet installation, even in a small space.

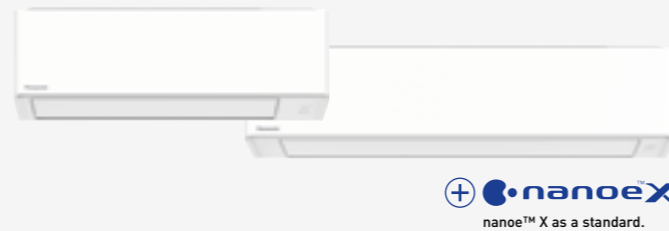

**nanoe<sup>™</sup>X**  
nanoe<sup>™</sup>X as a standard.

		Single phase					
		3,6 kW	5,0 kW	6,0 kW	7,1 kW	10,0 kW	
Kit		KIT-36PK4ZH5	KIT-50PK4ZH5	KIT-60PK4ZH5	KIT-71PK4ZH45	KIT-100PK4ZH45	
Remote controller		CZ-RTC5B	CZ-RTC5B	CZ-RTC5B	CZ-RTC5B	CZ-RTC5B	
Cooling capacity	Nominal (Min - Max)	kW	3,5(1,2 - 4,0)	5,0(1,2 - 5,6)	6,1(1,2 - 7,1)	7,1(2,2 - 9,0)	9,5(3,1 - 10,5)
EER <sup>1)</sup>	Nominal (Min - Max)	W/W	4,43(4,17 - 5,45)	4,10(3,03 - 5,45)	3,74(3,02 - 5,45)	3,76(2,69 - 5,79)	3,41(3,09 - 5,34)
<b>SEER<sup>2)</sup></b>			<b>7,7 A++</b>	<b>8,0 A++</b>	<b>7,1 A++</b>	<b>6,6 A++</b>	<b>6,6 A++</b>
Pdesign		kW	3,5	5,0	6,1	7,1	9,5
Input power	Nominal (Min - Max)	kW	0,79(0,22 - 0,96)	1,22(0,22 - 1,85)	1,63(0,22 - 2,35)	1,89(0,38 - 3,35)	2,79(0,58 - 3,40)
Annual energy consumption <sup>3)</sup>		kWh/a	160	219	301	377	504
Heating capacity	Nominal (Min - Max)	kW	4,0(1,2 - 5,0)	5,6(1,2 - 6,5)	7,0(1,2 - 8,0)	7,8(2,0 - 9,0)	9,5(3,1 - 11,5)
Heating capacity at -15 °C <sup>4)</sup>	Max	kW	3,4	5,0	5,1	5,8	8,9
COP <sup>1)</sup>	Nominal (Min - Max)	W/W	4,26(3,33 - 5,45)	4,03(3,10 - 5,45)	4,12(3,40 - 5,45)	4,00(3,16 - 5,56)	3,89(3,00 - 5,34)
<b>SCOP<sup>2)</sup></b>			<b>4,7 A++</b>	<b>4,6 A++</b>	<b>4,7 A++</b>	<b>4,6 A++</b>	<b>4,1 A+</b>
Pdesign at -10 °C		kW	3,1	4,5	4,6	5,2	8,0
Input power	Nominal (Min - Max)	kW	0,94(0,22 - 1,50)	1,39(0,22 - 2,10)	1,70(0,22 - 2,35)	1,95(0,36 - 2,85)	2,44(0,58 - 3,83)
Annual energy consumption <sup>3)</sup>		kWh/a	924	1369	1370	1583	2731
<b>Indoor unit</b>			<b>S-2545PK4E</b>	<b>S-5010PK4E</b>	<b>S-5010PK4E</b>	<b>S-5010PK4E</b>	<b>S-5010PK4E</b>
Air flow	Hi / Med / Lo	m <sup>3</sup> /min	11,5/9,5/7,0	17,0/15,5/12,0	21,0/19,0/16,5	21,0/19,0/16,5	22,5/20,0/17,5
Moisture removal volume		L/h	1,0	1,6	1,9	2,4	4,4
Sound pressure <sup>5)</sup>	Hi / Med / Lo	dB(A)	41/36/30	41/36/31	47/44/40	47/44/40	49/45/41
Sound power	Hi / Med / Lo	dB(A)	57/52/46	57/52/47	63/60/56	63/60/56	65/61/57
Dimension	H x W x D	mm	290 x 765 x 214	295 x 1060 x 249	295 x 1060 x 249	295 x 1060 x 249	295 x 1060 x 249
Net weight		kg	9	14	14	14	14
nanoe X Generator			Mark 3	Mark 3	Mark 3	Mark 3	Mark 3
<b>Outdoor unit</b>			<b>U-36PZH3E5</b>	<b>U-50PZH3E5</b>	<b>U-60PZH3E5</b>	<b>U-71PZH4E5</b>	<b>U-100PZH4E5</b>
Power supply		V	220 - 230 - 240	220 - 230 - 240	220 - 230 - 240	220 - 230 - 240	220 - 230 - 240
Current	Cool	A	3,90 - 3,75 - 3,60	5,80 - 5,55 - 5,30	7,65 - 7,30 - 7,00	9,55 - 9,15 - 8,75	13,80 - 13,20 - 12,60
	Heat	A	4,60 - 4,40 - 4,20	6,60 - 6,30 - 6,05	7,90 - 7,55 - 7,25	9,85 - 9,40 - 9,05	12,10 - 11,50 - 11,10
Air flow	Cool / Heat	m <sup>3</sup> /min	34,1/36,4	42,0/42,0	42,0/42,0	62,0/66,0	76,0/70,0
Sound pressure	Cool / Heat (Hi)	dB(A)	43/44	46/48	47/50	48/50	52/52
Sound power	Cool / Heat (Hi)	dB(A)	62/64	64/67	65/69	65/67	69/69
Dimension	H x W x D	mm	695 x 875 x 320	695 x 875 x 320	695 x 875 x 320	996 x 980 x 370	996 x 980 x 370
Net weight		kg	42	42	43	66	84
Piping diameter	Liquid	Inch (mm)	1/4 (6,35)	1/4 (6,35) <sup>6)</sup>	1/4 (6,35) <sup>6)</sup>	3/8 (9,52)	3/8 (9,52)
	Gas	Inch (mm)	1/2 (12,70)	1/2 (12,70) <sup>7)</sup>	1/2 (12,70) <sup>7)</sup>	5/8 (15,88)	5/8 (15,88)
Pipe length range		m	3 - 40	3 - 40	3 - 40	5 - 60	5 - 100
Elevation difference (in / out) <sup>8)</sup>		m	15/30	15/30	15/30	15/30	15/30
Pre-charged pipe length		m	30	30	30	30	30
Additional gas amount		g/m	15	15	15	30	40
Refrigerant [R32] / CO <sub>2</sub> Eq.		kg / T	1,13/0,76	1,13/0,76	1,15/0,78	1,95/1,32	2,70/1,82
Operating range	Cool Min ~ Max	°C	-15 ~ +46	-15 ~ +46	-15 ~ +46	-15 ~ +52	-20 <sup>9)</sup> ~ +52
	Heat Min ~ Max	°C	-20 ~ +24	-20 ~ +24	-20 ~ +24	-20 ~ +24	-20 ~ +24

### Technical focus

- Modern, flat design with a stylish matte white finish featuring
- DC fan motor for better efficiency and control
- Five-direction automatic air flow adjustment for cooling and heating
- Six directional piping outlet
- Quiet operation
- nanoe<sup>™</sup>X (Generator Mark 3: 48 trillion hydroxyl radicals/sec) as standard for better indoor air quality
- Wired remote control CZ-RTC6WBL and CZ-RTC6BL allows easy system setting via Bluetooth®
- Easy connection and control of external fan or ERV using the connector PAW-FDC on the indoor unit PCB. The external device can be controlled by the remote control of the Panasonic indoor unit

### Closed discharge port

When the unit is turned OFF, the flap closes completely to prevent dust getting into the unit and to keep the equipment clean.

### Piping outlet in six directions

Piping outlet is possible in six directions of; right, right rear, right bottom, left, left rear and left bottom, making the installation work more flexible.

### Air distribution is automatically altered depending on the operational mode of the unit

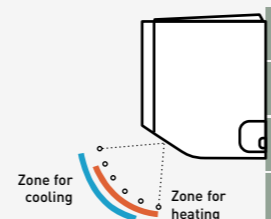

COMPATIBLE WITH ALL PANASONIC CONNECTIVITY SOLUTIONS. FOR DETAILED INFORMATION GO TO THE CONTROL SYSTEMS SECTION

#### Optional:

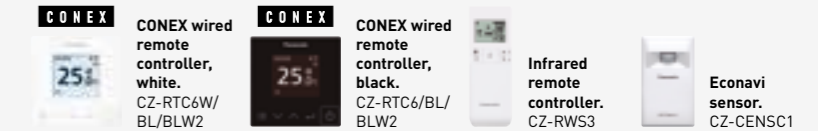

		Three phase		
		7,1 kW	10,0 kW	
Kit		KIT-71PK4ZH48	KIT-100PK4ZH48	
Remote controller		CZ-RTC5B	CZ-RTC5B	
Cooling capacity	Nominal (Min - Max)	kW	7,1(2,2 - 9,0)	9,5(3,1 - 10,5)
EER <sup>1)</sup>	Nominal (Min - Max)	W/W	3,76(2,69 - 5,79)	3,41(3,09 - 5,34)
<b>SEER<sup>2)</sup></b>			<b>6,6 A++</b>	<b>6,6 A++</b>
Pdesign		kW	7,1	9,5
Input power	Nominal (Min - Max)	kW	1,89(0,38 - 3,35)	2,79(0,58 - 3,40)
Annual energy consumption <sup>3)</sup>		kWh/a	377	504
Heating capacity	Nominal (Min - Max)	kW	7,8(2,0 - 9,0)	9,5(3,1 - 11,5)
Heating capacity at -15 °C <sup>4)</sup>	Max	kW	5,8	8,9
COP <sup>1)</sup>	Nominal (Min - Max)	W/W	4,00(3,16 - 5,56)	3,89(3,00 - 5,34)
<b>SCOP<sup>2)</sup></b>			<b>4,6 A++</b>	<b>4,1 A+</b>
Pdesign at -10 °C		kW	5,2	8,0
Input power	Nominal (Min - Max)	kW	1,95(0,36 - 2,85)	2,44(0,58 - 3,83)
Annual energy consumption <sup>3)</sup>		kWh/a	1583	2731
<b>Indoor unit</b>			<b>S-5010PK4E</b>	<b>S-5010PK4E</b>
Air flow	Hi / Med / Lo	m <sup>3</sup> /min	21,0/19,0/16,5	22,5/20,0/17,5
Moisture removal volume		L/h	2,4	4,4
Sound pressure <sup>5)</sup>	Hi / Med / Lo	dB(A)	47/44/40	49/45/41
Sound power	Hi / Med / Lo	dB(A)	63/60/56	65/61/57
Dimension	H x W x D	mm	295 x 1060 x 249	295 x 1060 x 249
Net weight		kg	14	14
nanoe X Generator			Mark 3	Mark 3
<b>Outdoor unit</b>			<b>U-71PZH4E8</b>	<b>U-100PZH4E8</b>
Power supply		V	380 - 400 - 415	380 - 400 - 415
Current	Cool	A	3,20 - 3,05 - 3,00	4,65 - 4,45 - 4,20
	Heat	A	3,30 - 3,15 - 3,00	4,05 - 3,85 - 3,70
Air flow	Cool / Heat	m <sup>3</sup> /min	62,0/66,0	76,0/70,0
Sound pressure	Cool / Heat (Hi)	dB(A)	48/50	52/52
Sound power	Cool / Heat (Hi)	dB(A)	65/67	69/69
Dimension	H x W x D	mm	996 x 980 x 370	996 x 980 x 370
Net weight		kg	66	82
Piping diameter	Liquid	Inch (mm)	3/8 (9,52)	3/8 (9,52)
	Gas	Inch (mm)	5/8 (15,88)	5/8 (15,88)
Pipe length range		m	5 - 60	5 - 100
Elevation difference (in / out) <sup>8)</sup>		m	15/30	15/30
Pre-charged pipe length		m	30	30
Additional gas amount		g/m	30	40
Refrigerant [R32] / CO <sub>2</sub> Eq.		kg / T	1,95/1,32	2,70/1,82
Operating range	Cool Min ~ Max	°C	-15 ~ +52	-20 <sup>9)</sup> ~ +52
	Heat Min ~ Max	°C	-20 ~ +24	-20 ~ +24

1) EER and COP calculation is based in accordance to EN 14511. 2) For models below 12 kW, the SEER and SCOP is calculated based on values of EU/626/2011. For models above 12 kW, the  $\eta_{cc}$  /  $\eta_{hp}$  values is calculated based on EN 14825. 3) Factory setting. 4) The value is based on the interpolation. 5) The sound pressure of the units shows the value measured of the position 1 m in front of the main body and 1 m below the unit. The sound pressure is measured in accordance with Eurovent 6/C/006-97 specification. 6) Connect the liquid socket tube (Ø6,35-Ø9,52) to the liquid tubing side indoor unit. 7) Connect the gas socket tube (Ø12,70-Ø15,88) to the gas tubing side indoor unit. 8) Outdoor unit located lower / outdoor unit located higher. 9) Pipe length up to 30 m. \*Recommended fuse for the indoor 3 A. \*\*Above values are in the case of nanoe<sup>™</sup>X OFF.

#### Accessories

<b>CZ-RTC6W</b>	CONEX wired remote controller (non-wireless), white
<b>CZ-RTC6WBL</b>	CONEX wired remote controller with Bluetooth®, white
<b>CZ-RTC6WBLW2</b>	CONEX wired remote controller with Wi-Fi and Bluetooth®, white
<b>CZ-RTC6</b>	CONEX wired remote controller (non-wireless), black
<b>CZ-RTC6BL</b>	CONEX wired remote controller with Bluetooth®, black
<b>CZ-RTC6BLW2</b>	CONEX wired remote controller with Wi-Fi and Bluetooth®, black
<b>CZ-RTC5B</b>	Wired remote controller with Econavi function
<b>CZ-RWS3</b>	Infrared remote controller

#### Accessories

<b>CZ-CAPWFC2</b>	Commercial Wi-Fi Adaptor
<b>PAW-PACR4</b>	Interface to run up to 4 indoor unit groups on backup and alternative run
<b>PAW-WTRAY</b>	Tray for condenser water compatible with outdoor elevation platform
<b>PAW-GRDBSE20</b>	Outdoor base ground support for noise and vibration absorption
<b>PAW-GRDSTD40</b>	Outdoor elevation platform 400x900x400 mm
<b>CZ-CENSC1</b>	Econavi energy saving sensor



SEER: For S-5010PK4E + U-50PZH3E5. SCOP: For S-2545PK4E + U-36PZH3E5 and S-5010PK4E + U-60PZH3E5. INTERNET CONTROL: Optional.

Rating conditions: Cooling indoor 27 °C DB / 19 °C WB. Cooling outdoor 35 °C DB / 24 °C WB. Heating indoor 20 °C DB. Heating outdoor 7 °C DB / 6 °C WB. (DB: Dry Bulb; WB: Wet Bulb). Specifications subject to change without notice. For detailed information about ErP / Energy Labelling, please visit our websites www.aircon.panasonic.eu or www.ptc.panasonic.eu.

## PACi NX Series Standard wall-mounted - PK4 - R32

The wall-mounted units with stylish matt color can be offered for many applications such as studios, gyms, high ceiling areas and even computer server rooms.

The compact design and flat face ensure discreet installation, even in a small space.

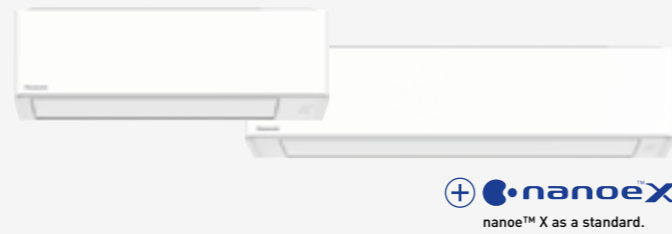

**nanoe<sup>™</sup> X**  
nanoe<sup>™</sup> X as a standard.

		Single phase						
		2,5 kW	3,6 kW	5,0 kW	6,0 kW	7,1 kW	10,0 kW	
Kit		KIT-25PK4Z5	KIT-36PK4Z5	KIT-50PK4Z5	KIT-60PK4Z5	KIT-71PK4Z5	KIT-100PK4Z5	
Remote controller		CZ-RTC5B	CZ-RTC5B	CZ-RTC5B	CZ-RTC5B	CZ-RTC5B	CZ-RTC5B	
Cooling capacity	Nominal (Min - Max)	kW	2,5(1,3 - 3,9)	3,5(1,3 - 4,0)	5,0(1,5 - 5,6)	6,1(2,0 - 7,1)	6,9(2,6 - 7,7)	9,0(3,0 - 9,7)
EER <sup>1)</sup>	Nominal (Min - Max)	W/W	4,39(3,68 - 5,00)	3,89(3,74 - 5,00)	3,40(3,03 - 6,25)	3,57(3,01 - 6,90)	3,29(2,77 - 5,00)	3,23(3,13 - 5,36)
<b>SEER<sup>2)</sup></b>			<b>6,6 A++</b>	<b>6,8 A++</b>	<b>7,2 A++</b>	<b>7,0 A++</b>	<b>6,0 A+</b>	<b>6,2 A++</b>
Pdesign		kW	2,5	3,5	5,0	6,1	6,9	9,0
Input power	Nominal (Min - Max)	kW	0,57(0,26 - 1,06)	0,90(0,26 - 1,07)	1,47(0,24 - 1,85)	1,71(0,29 - 2,36)	2,10(0,52 - 2,78)	2,79(0,56 - 3,10)
Annual energy consumption <sup>3)</sup>		kWh/a	133	181	243	305	402	508
Heating capacity	Nominal (Min - Max)	kW	2,8(1,3 - 4,6)	3,6(1,3 - 4,6)	5,0(1,5 - 6,4)	6,1(1,8 - 7,0)	7,1(2,1 - 8,1)	9,0(3,0 - 10,5)
Heating capacity at -15 °C <sup>4)</sup>	Max	kW	2,8	2,9	4,4	5,1	5,8	9,7
COP <sup>1)</sup>	Nominal (Min - Max)	W/W	4,52(3,54 - 5,65)	4,09(3,54 - 5,65)	4,20(3,17 - 7,50)	4,27(3,18 - 7,50)	4,10(3,38 - 6,36)	3,81(3,56 - 5,36)
<b>SCOP<sup>2)</sup></b>			<b>4,2 A+</b>	<b>4,4 A+</b>	<b>4,4 A+</b>	<b>4,6 A++</b>	<b>4,4 A+</b>	<b>4,0 A+</b>
Pdesign at -10 °C		kW	2,5	2,6	4,0	4,6	5,2	8,8
Input power	Nominal (Min - Max)	kW	0,62(0,23 - 1,30)	0,88(0,23 - 1,30)	1,19(0,20 - 2,02)	1,43(0,24 - 2,20)	1,73(0,33 - 2,40)	2,36(0,56 - 2,95)
Annual energy consumption <sup>3)</sup>		kWh/a	833	827	1271	1400	1654	3080
<b>Indoor unit</b>			<b>S-2545PK4E</b>	<b>S-2545PK4E</b>	<b>S-5010PK4E</b>	<b>S-5010PK4E</b>	<b>S-5010PK4E</b>	<b>S-5010PK4E</b>
Air flow	Hi / Med / Lo	m <sup>3</sup> /min	10,5/9,0/7,0	11,5/9,5/7,0	17,0/15,5/12,0	21,0/19,0/16,5	21,0/19,0/16,5	22,5/20,0/17,5
Moisture removal volume		L/h	0,4	1,0	1,6	1,9	2,2	4,0
Sound pressure <sup>5)</sup>	Hi / Med / Lo	dB(A)	39/34/29	41/36/30	41/36/31	47/44/40	47/44/40	49/45/41
Sound power	Hi / Med / Lo	dB(A)	55/50/45	57/52/46	57/52/47	63/60/56	63/60/56	65/61/57
Dimension	HxWxD	mm	290x765x214	290x765x214	295x1060x249	295x1060x249	295x1060x249	295x1060x249
Net weight		kg	9	9	14	14	14	14
nanoe X Generator			Mark 3	Mark 3	Mark 3	Mark 3	Mark 3	Mark 3
<b>Outdoor unit</b>			<b>U-25PZ3E5</b>	<b>U-36PZ3E5</b>	<b>U-50PZ3E5</b>	<b>U-60PZ3E5A</b>	<b>U-71PZ3E5A</b>	<b>U-100PZ3E5</b>
Power supply		V	220-230-240	220-230-240	220-230-240	220-230-240	220-230-240	220-230-240
Current	Cool	A	2,70-2,60-2,45	4,15-4,00-3,85	6,80-6,50-6,25	7,95-7,60-7,25	9,75-9,30-8,95	13,9-13,3-12,8
	Heat	A	2,90-2,80-2,65	4,10-3,95-3,80	5,60-5,35-5,10	6,65-6,35-6,10	8,00-7,70-7,35	11,8-11,3-10,8
Air flow	Cool / Heat	m <sup>3</sup> /min	33,6/34,0	33,6/34,0	32,7/31,9	42,6/41,5	44,7/45,9	73,0/73,0
Sound pressure	Cool / Heat (Hi)	dB(A)	46/47	46/47	46/46	47/48	48/49	52/52
Sound power	Cool / Heat (Hi)	dB(A)	64/66	64/66	64/64	64/65	66/68	70/70
Dimension	HxWxD	mm	619x824x299	619x824x299	619x824x299	695x875x320	695x875x320	996x980x370
Net weight		kg	32	32	35	42	50	83
Piping diameter	Liquid	Inch (mm)	1/4 (6,35)	1/4 (6,35)	1/4 (6,35) <sup>6)</sup>	1/4 (6,35) <sup>6)</sup>	1/4 (6,35) <sup>6)</sup>	3/8 (9,52)
	Gas	Inch (mm)	1/2 (12,70)	1/2 (12,70)	1/2 (12,70) <sup>7)</sup>	1/2 (12,70) <sup>7)</sup>	5/8 (15,88)	5/8 (15,88)
Pipe length range		m	3-15	3-15	3-20	3-40	3-40	5-50
Elevation difference (in / out) <sup>8)</sup>		m	15/15	15/15	15/15	15/30	20/30	15/30
Pre-charged pipe length		m	7,5	7,5	7,5	30	30	30
Additional gas amount		g/m	10	10	15	15	17	45
Refrigerant [R32] / CO <sub>2</sub> Eq.		kg / T	0,87/0,59	0,87/0,59	1,14/0,77	1,15/0,78	1,32/0,89	2,4/1,62
Operating range	Cool Min ~ Max	°C	-10 ~ +43	-10 ~ +43	-10 ~ +43	-10 ~ +43	-10 ~ +43	-10 ~ +43
	Heat Min ~ Max	°C	-15 ~ +24	-15 ~ +24	-15 ~ +24	-15 ~ +24	-15 ~ +24	-15 ~ +24

### Technical focus

- Modern, flat design with a stylish matte white finish featuring
- DC fan motor for better efficiency and control
- Five-direction automatic air flow adjustment for cooling and heating
- Six directional piping outlet
- Quiet operation
- nanoe<sup>™</sup> X (Generator Mark 3: 48 trillion hydroxyl radicals/sec) as standard for better indoor air quality
- Wired remote control CZ-RTC6WBL and CZ-RTC6BL allows easy system setting via Bluetooth®
- Easy connection and control of external fan or ERV using the connector PAW-FDC on the indoor unit PCB. The external device can be controlled by the remote control of the Panasonic indoor unit

### Closed discharge port

When the unit is turned OFF, the flap closes completely to prevent dust getting into the unit and to keep the equipment clean.

### Piping outlet in six directions

Piping outlet is possible in six directions of; right, right rear, right bottom, left, left rear and left bottom, making the installation work more flexible.

**Air distribution is automatically altered depending on the operational mode of the unit**

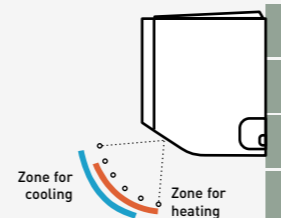

COMPATIBLE WITH ALL PANASONIC CONNECTIVITY SOLUTIONS. FOR DETAILED INFORMATION GO TO THE CONTROL SYSTEMS SECTION

### Optional:

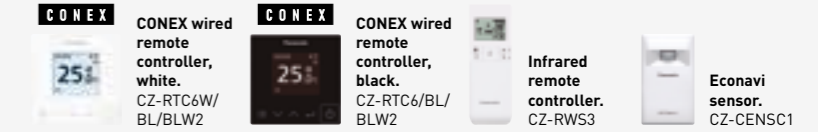

		Three phase	
		10,0 kW	
Kit		KIT-100PK4Z8	
Remote controller		CZ-RTC5B	
Cooling capacity	Nominal (Min - Max)	kW	9,0(3,0 - 9,7)
EER <sup>1)</sup>	Nominal (Min - Max)	W/W	3,23(3,13 - 5,36)
<b>SEER<sup>2)</sup></b>			<b>6,2 A++</b>
Pdesign		kW	9,0
Input power	Nominal (Min - Max)	kW	2,79(0,56 - 3,10)
Annual energy consumption <sup>3)</sup>		kWh/a	508
Heating capacity	Nominal (Min - Max)	kW	9,0(3,0 - 10,5)
Heating capacity at -15 °C <sup>4)</sup>	Max	kW	9,7
COP <sup>1)</sup>	Nominal (Min - Max)	W/W	3,81(3,56 - 5,36)
<b>SCOP<sup>2)</sup></b>			<b>4,0 A+</b>
Pdesign at -10 °C		kW	8,8
Input power	Nominal (Min - Max)	kW	2,36(0,56 - 2,95)
Annual energy consumption <sup>3)</sup>		kWh/a	3080
<b>Indoor unit</b>			<b>S-5010PK4E</b>
Air flow	Hi / Med / Lo	m <sup>3</sup> /min	22,5/20,0/17,5
Moisture removal volume		L/h	4,0
Sound pressure <sup>5)</sup>	Hi / Med / Lo	dB(A)	49/45/41
Sound power	Hi / Med / Lo	dB(A)	65/61/57
Dimension	HxWxD	mm	295x1060x249
Net weight		kg	14
nanoe X Generator			Mark 3
<b>Outdoor unit</b>			<b>U-100PZ3E8</b>
Power supply		V	380-400-415
Current	Cool	A	4,65-4,45-4,25
	Heat	A	3,95-3,75-3,60
Air flow	Cool / Heat	m <sup>3</sup> /min	73,0/73,0
Sound pressure	Cool / Heat (Hi)	dB(A)	52/52
Sound power	Cool / Heat (Hi)	dB(A)	70/70
Dimension	HxWxD	mm	996x980x370
Net weight		kg	83
Piping diameter	Liquid	Inch (mm)	3/8 (9,52)
	Gas	Inch (mm)	5/8 (15,88)
Pipe length range		m	5-50
Elevation difference (in / out) <sup>8)</sup>		m	15/30
Pre-charged pipe length		m	30
Additional gas amount		g/m	45
Refrigerant [R32] / CO <sub>2</sub> Eq.		kg / T	2,4/1,62
Operating range	Cool Min ~ Max	°C	-10 ~ +43
	Heat Min ~ Max	°C	-15 ~ +24

1) EER and COP calculation is based in accordance to EN 14511. 2) For models below 12 kW, the SEER and SCOP is calculated based on values of EU/626/2011. For models above 12 kW, the  $\eta_{cc}$  /  $\eta_{hs}$  values is calculated based on EN 14825. 3) Factory setting. 4) The value is based on the interpolation. 5) The sound pressure of the units shows the value measured of the position 1 m in front of the main body and 1 m below the unit. The sound pressure is measured in accordance with Eurovent 6/C/006-97 specification. 6) Connect the liquid socket tube (Ø6,35-Ø9,52) to the liquid tubing side indoor unit. 7) Connect the gas socket tube (Ø12,70-Ø15,88) to the gas tubing side indoor unit. 8) Outdoor unit located lower / outdoor unit located higher. \*Recommended fuse for the indoor 3 A. \*\*Above values are in the case of nanoe<sup>™</sup> X OFF.

Accessories	
<b>CZ-RTC6W</b>	CONEX wired remote controller (non-wireless), white
<b>CZ-RTC6WBL</b>	CONEX wired remote controller with Bluetooth®, white
<b>CZ-RTC6WBLW2</b>	CONEX wired remote controller with Wi-Fi and Bluetooth®, white
<b>CZ-RTC6</b>	CONEX wired remote controller (non-wireless), black
<b>CZ-RTC6BL</b>	CONEX wired remote controller with Bluetooth®, black
<b>CZ-RTC6BLW2</b>	CONEX wired remote controller with Wi-Fi and Bluetooth®, black
<b>CZ-RTC5B</b>	Wired remote controller with Econavi function
<b>CZ-RWS3</b>	Infrared remote controller

Accessories	
<b>CZ-CAPWFC2</b>	Commercial Wi-Fi Adaptor
<b>PAW-PACR4</b>	Interface to run up to 4 indoor unit groups on backup and alternative run
<b>PAW-WTRAY</b>	Tray for condenser water compatible with outdoor elevation platform
<b>PAW-GRDBSE20</b>	Outdoor base ground support for noise and vibration absorption
<b>PAW-GRDSTD40</b>	Outdoor elevation platform 400x900x400 mm
<b>CZ-CENSC1</b>	Econavi energy saving sensor



SEER: For S-5010PK4E + U-50PZ3E5. SCOP: For S-5010PK4E + U-60PZ3E5A. INTERNET CONTROL: Optional.

Rating conditions: Cooling indoor 27 °C DB / 19 °C WB. Cooling outdoor 35 °C DB / 24 °C WB. Heating indoor 20 °C DB. Heating outdoor 7 °C DB / 6 °C WB. (DB: Dry Bulb; WB: Wet Bulb). Specifications subject to change without notice. For detailed information about ErP / Energy Labelling, please visit our websites www.aircon.panasonic.eu or www.ptc.panasonic.eu.

## PACi NX Series Elite and Standard 4 way 60x60 cassette - PY3 - R32

- From 2,5 to 6,0 kW (4 capacity sizes)
- Maximum SEER: 7,3 A++ / SCOP: 4,7 A++\*
- Built-in drain pump
- DC drain pump and float switch to reduce the noise
- nanoe™ X (Generator Mark 2: 9,6 trillion hydroxyl radicals/sec) as standard for better indoor air quality

\*For Elite 3,6 kW model.



**nanoe™ X**  
nanoe™ X as a standard.

Elite		Single phase		
		3,6 kW	5,0 kW	6,0 kW
Kit		KIT-36PY3ZH5	KIT-50PY3ZH5	KIT-60PY3ZH5
Remote controller		CZ-RTC5B	CZ-RTC5B	CZ-RTC5B
Cooling capacity	Nominal (Min - Max) kW	3,6 (1,2 - 4,0)	5,0 (1,2 - 5,6)	6,0 (1,2 - 6,5)
EER <sup>1)</sup>	Nominal (Min - Max) W/W	4,50 (4,04 - 5,45)	3,76 (3,41 - 5,45)	3,43 (2,77 - 5,45)
<b>SEER<sup>2)</sup></b>		<b>7,3 A++</b>	<b>7,0 A++</b>	<b>6,7 A++</b>
Pdesign	kW	3,6	5,0	6,0
Input power	Nominal (Min - Max) kW	0,80 (0,22 - 0,99)	1,33 (0,22 - 1,64)	1,75 (0,20 - 2,35)
Annual energy consumption <sup>3)</sup>	kWh/a	400	685	875
Heating capacity	Nominal (Min - Max) kW	4,0 (1,2 - 5,0)	5,6 (1,2 - 6,5)	7,0 (1,2 - 7,5)
Heating capacity at -15 °C <sup>4)</sup>	Max kW	3,2	4,1	4,8
COP <sup>1)</sup>	Nominal (Min - Max) W/W	4,12 (3,45 - 5,45)	3,37 (2,95 - 5,45)	3,35 (3,38 - 5,45)
<b>SCOP<sup>2)</sup></b>		<b>4,7 A++</b>	<b>4,6 A++</b>	<b>4,3 A+</b>
Pdesign at -10 °C	kW	3,6	4,5	4,6
Input power	Nominal (Min - Max) kW	0,97 (0,22 - 1,45)	1,66 (0,22 - 2,20)	2,09 (0,22 - 2,22)
Annual energy consumption <sup>3)</sup>	kWh/a	1073	1370	1495
Indoor unit		S-36PY3E	S-50PY3E	S-60PY3E
Air flow	Hi / Med / Lo m <sup>3</sup> /min	9,5/7,5/6,0	12,0/9,5/6,5	14,0/10,5/8,0
Moisture removal volume	L/h	1,5	2,5	2,8
Sound pressure <sup>5)</sup>	Hi / Med / Lo dB(A)	34/30/25	39/34/27	43/37/31
Sound power	Hi / Med / Lo dB(A)	49/45/40	54/49/42	58/52/46
Dimension	Indoor (HxWxD) mm	243x575x575	243x575x575	243x575x575
	Panel (HxWxD) mm	30x625x625	30x625x625	30x625x625
Net weight	Indoor / Panel kg	15/2,8	15/2,8	15/2,8
nanoe X Generator		Mark 2	Mark 2	Mark 2
Outdoor unit		U-36PZH3E5	U-50PZH3E5	U-60PZH3E5
Power supply	V	220 - 230 - 240	220 - 230 - 240	220 - 230 - 240
Current	Cool A	3,95 - 3,60 - 3,60	5,30 - 5,00 - 5,75	8,20 - 7,85 - 7,60
	Heat A	4,75 - 4,55 - 4,35	7,85 - 7,50 - 7,20	9,70 - 9,25 - 8,90
Air flow	Cool / Heat m <sup>3</sup> /min	34,1/36,4	42,0/42,0	42,0/42,0
Sound pressure	Cool / Heat (Hi) dB(A)	43/44	46/48	47/50
Sound power	Cool / Heat (Hi) dB(A)	62/64	64/67	65/69
Dimension	HxWxD mm	695x875x320	695x875x320	695x875x320
Net weight	kg	42	42	43
Piping diameter	Liquid Inch (mm)	1/4 (6,35)	1/4 (6,35)	1/4 (6,35) <sup>6)</sup>
	Gas Inch (mm)	1/2 (12,70)	1/2 (12,70)	1/2 (12,70) <sup>7)</sup>
Pipe length range	m	3 - 40	3 - 40	3 - 40
Elevation difference (in / out) <sup>8)</sup>	m	15/30	15/30	15/30
Pre-charged pipe length	m	30	30	30
Additional gas amount	g/m	15	15	15
Refrigerant (R32) / CO <sub>2</sub> Eq.	kg / T	1,13/0,76	1,13/0,76	1,15/0,78
Operating range	Cool Min ~ Max °C	-15 ~ +46	-15 ~ +46	-15 ~ +46
	Heat Min ~ Max °C	-20 ~ +24	-20 ~ +24	-20 ~ +24

### Compact and stylish design

- Required ceiling depth of only 250 mm
- Exposed area is only 30 mm

### Individual flap control

Better control of the air flow with 4 motors, providing individual flap control. Perfect air distribution without direct air flow, to reduce the feeling of cold drafts.

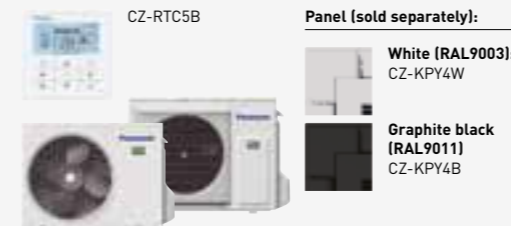
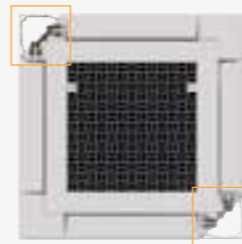

Panel (sold separately):

White (RAL9003):  
CZ-KPY4W

Graphite black (RAL9011):  
CZ-KPY4B

COMPATIBLE WITH ALL PANASONIC CONNECTIVITY SOLUTIONS. FOR DETAILED INFORMATION GO TO THE CONTROL SYSTEMS SECTION

Optional:



CONEX wired remote controller, white.  
CZ-RTC6W/BL/BLW2



CONEX wired remote controller, black.  
CZ-RTC6/BL/BLW2



Infrared remote controller.  
CZ-RWS3 + CZ-RWRY3W

Econavi sensor.  
CZ-CENSC1

Standard		Single phase			
		2,5 kW	3,6 kW	5,0 kW	6,0 kW
Kit		KIT-25PY3Z5	KIT-36PY3Z5	KIT-50PY3Z5	KIT-60PY3Z5
Remote controller		CZ-RTC5B	CZ-RTC5B	CZ-RTC5B	CZ-RTC5B
Cooling capacity	Nominal (Min - Max) kW	2,5 (1,5 - 3,9)	3,6 (1,5 - 4,0)	5,0 (1,5 - 5,6)	6,0 (2,0 - 7,0)
EER <sup>1)</sup>	Nominal (Min - Max) W/W	4,46 (3,55 - 5,88)	3,96 (3,57 - 5,88)	3,50 (3,03 - 6,25)	3,39 (2,77 - 6,90)
<b>SEER<sup>2)</sup></b>		<b>6,5 A++</b>	<b>6,7 A++</b>	<b>7,3 A++</b>	<b>6,8 A++</b>
Pdesign	kW	2,5	3,6	5,0	6,0
Input power	Nominal (Min - Max) kW	0,56 (0,26 - 1,10)	0,91 (0,26 - 1,12)	1,43 (0,24 - 1,85)	1,77 (0,29 - 2,53)
Annual energy consumption <sup>3)</sup>	kWh/a	134	188	238	3,05
Heating capacity	Nominal (Min - Max) kW	3,2 (1,5 - 4,6)	3,6 (1,5 - 4,6)	5,0 (1,5 - 6,4)	6,0 (1,8 - 7,0)
Heating capacity at -15 °C <sup>4)</sup>	Max kW	2,6	2,6	3,7	4,7
COP <sup>1)</sup>	Nominal (Min - Max) W/W	4,44 (3,41 - 6,52)	4,29 (3,38 - 6,52)	3,94 (2,91 - 7,50)	3,61 (2,86 - 7,60)
<b>SCOP<sup>2)</sup></b>		<b>4,6 A++</b>	<b>4,3 A+</b>	<b>4,4 A+</b>	<b>4,2 A+</b>
Pdesign at -10 °C	kW	2,8	2,8	4,0	4,6
Input power	Nominal (Min - Max) kW	0,72 (0,23 - 1,35)	0,84 (0,23 - 1,36)	1,27 (0,20 - 2,20)	1,66 (0,24 - 2,45)
Annual energy consumption <sup>3)</sup>	kWh/a	850	912	1264	1500
Indoor unit		S-25PY3E	S-36PY3E	S-50PY3E	S-60PY3E
Air flow	Hi / Med / Lo m <sup>3</sup> /min	8,5/7,0/6,0	9,5/7,0/6,0	12,0/9,5/6,5	14,0/10,5/8,0
Moisture removal volume	L/h	0,7	1,5	2,3	2,8
Sound pressure <sup>5)</sup>	Hi / Med / Lo dB(A)	31/28/25	34/30/25	39/34/27	43/37/31
Sound power	Hi / Med / Lo dB(A)	46/43/40	49/45/40	54/49/42	58/52/46
Dimension	Indoor (HxWxD) mm	243x575x575	243x575x575	243x575x575	243x575x575
	Panel (HxWxD) mm	30x625x625	30x625x625	30x625x625	30x625x625
Net weight	Indoor / Panel kg	15/2,8	15/2,8	15/2,8	15/2,8
nanoe X Generator		Mark 2	Mark 2	Mark 2	Mark 2
Outdoor unit		U-25PZ3E5	U-36PZ3E5	U-50PZ3E5	U-60PZ3E5A
Power supply	V	220 - 230 - 240	220 - 230 - 240	220 - 230 - 240	220 - 230 - 240
Current	Cool A	2,65 - 2,55 - 2,45	4,20 - 4,05 - 3,85	6,65 - 6,35 - 6,10	8,20 - 7,85 - 7,55
	Heat A	3,40 - 3,25 - 3,10	3,95 - 3,75 - 3,60	5,695 - 5,70 - 5,45	7,70 - 7,35 - 7,05
Air flow	Cool / Heat m <sup>3</sup> /min	33,6/34,0	32,6/34,0	32,7/31,9	42,6/41,5
Sound pressure	Cool / Heat (Hi) dB(A)	46/47	46/47	46/48	47/48
Sound power	Cool / Heat (Hi) dB(A)	64/66	64/66	64/64	64/65
Dimension	HxWxD mm	619x824x299	619x824x299	619x824x299	695x875x320
Net weight	kg	32	32	35	46
Piping diameter	Liquid Inch (mm)	1/4 (6,35)	1/4 (6,35)	1/4 (6,35)	1/4 (6,35) <sup>5)</sup>
	Gas Inch (mm)	1/2 (12,70)	1/2 (12,70)	1/2 (12,70)	1/2 (12,70) <sup>6)</sup>
Pipe length range	m	3 - 15	3 - 15	3 - 20	3 - 40
Elevation difference (in / out) <sup>8)</sup>	m	15/15	15/15	15/15	15/30
Pre-charged pipe length	m	7,5	7,5	7,5	30
Additional gas amount	g/m	10	10	15	15
Refrigerant (R32) / CO <sub>2</sub> Eq.	kg / T	0,87/0,59	0,87/0,59	1,14/0,77	1,15/0,78
Operating range	Cool Min ~ Max °C	-10 ~ +43	-10 ~ +43	-10 ~ +43	-10 ~ +43
	Heat Min ~ Max °C	-15 ~ +24	-15 ~ +24	-15 ~ +24	-15 ~ +24

1) EER and COP calculation is based in accordance to EN 14511. 2) For models below 12 kW, the SEER and SCOP is calculated based on values of EU/626/2011. For models above 12 kW, the  $\eta_{e,c}$  /  $\eta_{e,h}$  values is calculated based on EN 14825. 3) Factory setting. 4) The value is based on the interpolation. 5) The sound pressure of the units shows the value measured of the position 1,5 m below the unit. The sound pressure is measured in accordance with Eurovent 6/C/006-97 specification. 6) Connect the liquid socket tube (Ø6,35-Ø9,52) to the liquid tubing side indoor unit. 7) Connect the gas socket tube (Ø12,70-Ø15,88) to the gas tubing side indoor unit. 8) Outdoor unit located lower / outdoor unit located higher. \*Recommended fuse for the indoor 3 A. \*\*Above values are in the case of nanoe™ X OFF.

### Accessories

<b>CZ-RTC6W</b>	CONEX wired remote controller (non-wireless), white
<b>CZ-RTC6WBL</b>	CONEX wired remote controller with Bluetooth®, white
<b>CZ-RTC6WBLW2</b>	CONEX wired remote controller with Wi-Fi and Bluetooth®, white
<b>CZ-RTC6</b>	CONEX wired remote controller (non-wireless), black
<b>CZ-RTC6BL</b>	CONEX wired remote controller with Bluetooth®, black
<b>CZ-RTC6BLW2</b>	CONEX wired remote controller with Wi-Fi and Bluetooth®, black
<b>CZ-RTC5B</b>	Wired remote controller with Econavi function
<b>CZ-RWS3 + CZ-RWRY3W</b>	Infrared remote controller and receiver
<b>CZ-CAPWFC2</b>	Commercial Wi-Fi Adaptor

### Accessories

<b>CZ-KPY4W</b>	<b>NEW!</b> Panel for 4 way 60x60 cassette, white (RAL9003)
<b>CZ-KPY4B*</b>	<b>NEW!</b> Panel for 4 way 60x60 cassette, graphite black (RAL9011)
<b>PAW-PACR4</b>	Interface to run up to 4 indoor unit groups on backup and alternative run
<b>PAW-WTRAY</b>	Tray for condenser water compatible with outdoor elevation platform
<b>PAW-GRDBSE20</b>	Outdoor base ground support for noise and vibration absorption
<b>PAW-GRDSTD40</b>	Outdoor elevation platform 400x900x400 mm
<b>CZ-CENSC1</b>	Econavi energy saving sensor

\*Available in Autumn 2026.



SEER and SCOP: For S-36PY3E + U-36PZH3E5. ECONAVI and INTERNET CONTROL: Optional.



SEER: For S-50PY3E + U-50PZ3E5. SCOP: For S-25PY3E + U-25PZ3E5. ECONAVI and INTERNET CONTROL: Optional.

Rating conditions: Cooling indoor 27 °C DB / 19 °C WB. Cooling outdoor 35 °C DB / 24 °C WB. Heating indoor 20 °C DB. Heating outdoor 7 °C DB / 6 °C WB. (DB: Dry Bulb; WB: Wet Bulb). Specifications subject to change without notice. For detailed information about ERP / Energy Labelling, please visit our websites www.aircon.panasonic.eu or www.ptc.panasonic.eu.

## PACi NX Series Elite 4 way 90x90 cassette - PU3 - R32

## 4 way 90x90 cassette - PU3.

Powerful turbo fan and intelligent Econavi sensor ensure high energy efficiency, and nanoe™ X, which is equipped as standard, provides an exceptional level of indoor air quality.



nanoe™ X as a standard.

		Single phase						
		3,6 kW	5,0 kW	6,0 kW	7,1 kW	10,0 kW	12,5 kW	14,0 kW
Kit		KIT-36PU3ZH5	KIT-50PU3ZH5	KIT-60PU3ZH5	KIT-71PU3ZH5	KIT-100PU3ZH5	KIT-125PU3ZH5	KIT-140PU3ZH5
Remote controller		CZ-RTC5B	CZ-RTC5B	CZ-RTC5B	CZ-RTC5B	CZ-RTC5B	CZ-RTC5B	CZ-RTC5B
Cooling capacity	Nom (Min - Max) kW	3,6 (1,2 - 4,0)	5,0 (1,2 - 5,6)	6,0 (1,2 - 7,1)	7,1 (2,2 - 9,0)	9,5 (3,1 - 12,5)	12,5 (3,2 - 14,0)	13,4 (3,3 - 16,0)
EER <sup>1)</sup>	Nom (Min - Max) W/W	5,45 (4,60 - 5,45)	4,31 (3,86 - 5,45)	4,05 (3,02 - 5,45)	4,06 (2,69 - 5,79)	4,42 (3,42 - 5,34)	3,80 (3,08 - 5,33)	3,60 (2,74 - 5,32)
<b>SEER / η<sub>sc</sub><sup>2)</sup></b>		<b>8,9 A+++</b>	<b>8,6 A+++</b>	<b>8,0 A++</b>	<b>7,7 A++</b>	<b>7,8 A++</b>	<b>304,3%</b>	<b>286,6%</b>
Pdesign	kW	3,6	5,0	6,0	7,1	9,5	12,5	13,4
Input power	Nom (Min - Max) kW	0,66 (0,22 - 0,87)	1,16 (0,22 - 1,45)	1,48 (0,22 - 2,35)	1,75 (0,38 - 3,35)	2,15 (0,58 - 3,65)	3,29 (0,60 - 4,55)	3,72 (0,62 - 5,85)
Annual energy consumption <sup>3)</sup>	kWh/a	142	203	263	323	426	—	—
Heating capacity	Nom (Min - Max) kW	4,0 (1,2 - 5,0)	5,6 (1,2 - 6,5)	7,0 (1,2 - 8,0)	8,0 (2,0 - 9,0)	11,2 (3,1 - 14,0)	14,0 (3,2 - 16,0)	16,0 (3,3 - 18,0)
Heating capacity at -15 °C <sup>4)</sup>	Max kW	3,2	4,1	5,1	7,5	11,9	13,4	15,0
COP <sup>1)</sup>	Nom (Min - Max) W/W	5,41 (4,55 - 5,45)	4,24 (4,19 - 5,45)	4,02 (3,40 - 5,45)	4,30 (3,16 - 5,56)	5,00 (3,64 - 5,54)	4,61 (3,37 - 5,52)	4,30 (3,27 - 5,50)
<b>SCOP / η<sub>sh</sub><sup>2)</sup></b>		<b>5,1 A+++</b>	<b>4,9 A++</b>	<b>4,8 A++</b>	<b>4,8 A++</b>	<b>4,9 A++</b>	<b>186,0%</b>	<b>181,2%</b>
Pdesign at -10 °C	kW	3,6	4,5	4,7	5,2	8,0	9,5	10,6
Input power	Nom (Min - Max) kW	0,74 (0,22 - 1,10)	1,32 (0,22 - 1,55)	1,74 (0,22 - 2,35)	1,86 (0,36 - 2,85)	2,24 (0,56 - 3,85)	3,04 (0,58 - 4,75)	3,72 (0,60 - 5,50)
Annual energy consumption <sup>3)</sup>	kWh/a	988	1286	1371	1517	2286	—	—
<b>Indoor unit</b>		<b>S-3650PU3E</b>	<b>S-3650PU3E</b>	<b>S-6071PU3E</b>	<b>S-6071PU3E</b>	<b>S-1014PU3E</b>	<b>S-1014PU3E</b>	<b>S-1014PU3E</b>
Air flow	Hi / Med / Lo m <sup>3</sup> /min	14,5/13,0/11,5	16,5/13,5/11,5	21,0/16,0/13,0	22,0/16,0/13,0	36,0/26,0/18,0	37,0/27,0/19,0	38,0/29,0/20,0
Moisture removal volume	L/h	0,7	1,6	1,7	2,5	4,8	4,9	4,9
Sound pressure <sup>5)</sup>	Hi / Med / Lo dB(A)	30/28/27	32/29/27	36/31/28	37/31/28	45/38/32	46/39/33	47/40/34
Sound power	Hi / Med / Lo dB(A)	45/43/42	47/44/42	51/46/43	52/46/43	60/53/47	61/54/48	62/55/49
Dimension	Indoor (HxWxD) mm	256 x 840 x 840	256 x 840 x 840	256 x 840 x 840	256 x 840 x 840	319 x 840 x 840	319 x 840 x 840	319 x 840 x 840
	Panel (HxWxD) mm	33,5 x 950 x 950	33,5 x 950 x 950	33,5 x 950 x 950	33,5 x 950 x 950	33,5 x 950 x 950	33,5 x 950 x 950	33,5 x 950 x 950
Net weight	Indoor / Panel kg	19/5	19/5	20/5	20/5	25/5	25/5	25/5
nanoe X Generator		Mark 1	Mark 1	Mark 1	Mark 1	Mark 1	Mark 1	Mark 1
<b>Outdoor unit</b>		<b>U-36PZH3E5</b>	<b>U-50PZH3E5</b>	<b>U-60PZH3E5</b>	<b>U-71PZH4E5</b>	<b>U-100PZH4E5</b>	<b>U-125PZH4E5</b>	<b>U-140PZH4E5</b>
Power supply	V	220-230-240	220-230-240	220-230-240	220-230-240	220-230-240	220-230-240	220-230-240
Current	Cool A	3,25-3,10-3,00	5,50-5,25-5,05	6,95-6,65-6,35	8,85-8,45-8,10	10,06-10,02-9,75	16,10-15,40-14,70	18,20-17,40-16,70
	Heat A	3,60-3,45-3,30	6,25-6,00-5,75	8,05-7,70-7,40	9,40-9,00-8,60	10,90-10,60-10,10	14,90-14,20-13,60	18,20-17,40-16,70
Air flow	Cool / Heat m <sup>3</sup> /min	34,1/36,4	42,0/42,0	42,0/42,0	62,0/66,0	76,0/70,0	86,0/78,0	89,0/83,0
Sound pressure	Cool / Heat (Hi) dB(A)	43/44	46/48	47/50	48/50	52/52	55/55	56/56
Sound power	Cool / Heat (Hi) dB(A)	62/64	64/67	65/69	65/67	69/69	73/73	74/74
Dimension	HxWxD mm	695 x 875 x 320	695 x 875 x 320	695 x 875 x 320	996 x 980 x 370	996 x 980 x 370	996 x 980 x 370	996 x 980 x 370
Net weight	kg	42	42	43	66	84	86	86
Piping diameter	Liquid Inch (mm)	1/4 (6,35)	1/4 (6,35)	1/4 (6,35) <sup>6)</sup>	3/8 (9,52)	3/8 (9,52)	3/8 (9,52)	3/8 (9,52)
	Gas Inch (mm)	1/2 (12,70)	1/2 (12,70)	1/2 (12,70) <sup>7)</sup>	5/8 (15,88)	5/8 (15,88)	5/8 (15,88)	5/8 (15,88)
Pipe length range	m	3-40	3-40	3-40	5-60	5-100	5-100	5-100
Elevation difference (in / out) <sup>8)</sup>	m	15/30	15/30	15/30	15/30	15/30	15/30	15/30
Pre-charged pipe length	m	30	30	30	30	30	30	30
Additional gas amount	g/m	15	15	15	30	40	40	40
Refrigerant (R32) / CO <sub>2</sub> Eq.	kg / T	1,13/0,76	1,13/0,76	1,15/0,78	1,95/1,32	2,70/1,82	3,00/2,03	3,00/2,03
Operating range	Cool Min ~ Max °C	-15 ~ +46	-15 ~ +46	-15 ~ +46	-15 ~ +52	-20 <sup>9)</sup> ~ +52	-20 <sup>9)</sup> ~ +52	-20 <sup>9)</sup> ~ +52
	Heat Min ~ Max °C	-20 ~ +24	-20 ~ +24	-20 ~ +24	-20 ~ +24	-20 ~ +24	-20 ~ +24	-20 ~ +24

## Technical focus

- High performance turbo fan
- Econavi: An optional intelligent sensor to reduce waste of energy
- nanoe™ X (Generator Mark 1: 4,8 trillion hydroxyl radicals/sec) as standard for better indoor air quality, indoor unit internal cleaning with nanoe™ X plus dry operation
- New graphite black and white panels providing options to suit a variety of light commercial applications
- Lower noise in low fan operation
- Light weight, easy piping and integrated drain pump for quick installation
- Wired remote control CZ-RTC6WBL and CZ-RTC6BL allows easy system setting via Bluetooth®
- High volume fresh air input with optional air-intake plenum and chamber (CZ-FDU3+CZ-ATU2)

## White and graphite black panels available for the 4 way 90x90 cassette.

Standard panel, white (RAL9003).  
CZ-KPU3



Econavi panel, white (RAL9003).  
CZ-KPU3A



Standard panel, graphite black (RAL9011).  
CZ-KPU3B



COMPATIBLE WITH ALL PANASONIC CONNECTIVITY SOLUTIONS. FOR DETAILED INFORMATION GO TO THE CONTROL SYSTEMS SECTION

## Optional:

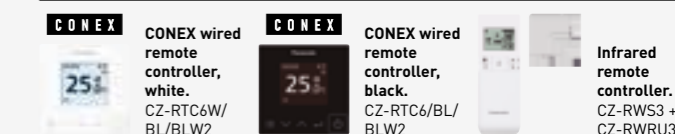

		Three phase			
		7,1 kW	10,0 kW	12,5 kW	14,0 kW
Kit		KIT-71PU3ZH48	KIT-100PU3ZH48	KIT-125PU3ZH48	KIT-140PU3ZH48
Remote controller		CZ-RTC5B	CZ-RTC5B	CZ-RTC5B	CZ-RTC5B
Cooling capacity	Nominal (Min - Max) kW	7,1 (2,2 - 9,0)	9,5 (3,1 - 12,5)	12,5 (3,2 - 14,0)	13,4 (3,3 - 16,0)
EER <sup>1)</sup>	Nominal (Min - Max) W/W	4,06 (2,69 - 5,79)	4,42 (3,42 - 5,34)	3,80 (3,08 - 5,33)	3,60 (2,74 - 5,32)
<b>SEER / η<sub>sc</sub><sup>2)</sup></b>		<b>7,7 A++</b>	<b>7,2 A++</b>	<b>303,0%</b>	<b>286,6%</b>
Pdesign	kW	7,1	9,5	12,5	13,4
Input power	Nominal (Min - Max) kW	1,75 (0,38 - 3,35)	2,15 (0,58 - 3,65)	3,29 (0,60 - 4,55)	3,72 (0,62 - 5,85)
Annual energy consumption <sup>3)</sup>	kWh/a	323	426	—	—
Heating capacity	Nominal (Min - Max) kW	8,0 (2,0 - 9,0)	11,2 (3,1 - 14,0)	14,0 (3,2 - 16,0)	16,0 (3,3 - 18,0)
Heating capacity at -15 °C <sup>4)</sup>	Max kW	7,5	11,9	13,4	15,0
COP <sup>1)</sup>	Nominal (Min - Max) W/W	4,30 (3,16 - 5,56)	5,00 (3,64 - 5,54)	4,61 (3,37 - 5,52)	4,30 (3,27 - 5,50)
<b>SCOP / η<sub>sh</sub><sup>2)</sup></b>		<b>4,8 A++</b>	<b>4,9 A++</b>	<b>186,0%</b>	<b>181,1%</b>
Pdesign at -10 °C	kW	5,2	8,0	9,5	10,6
Input power	Nominal (Min - Max) kW	1,86 (0,36 - 2,85)	2,24 (0,56 - 3,85)	3,04 (0,58 - 4,75)	3,72 (0,60 - 5,50)
Annual energy consumption <sup>3)</sup>	kWh/a	1517	2286	—	—
<b>Indoor unit</b>		<b>S-6071PU3E</b>	<b>S-1014PU3E</b>	<b>S-1014PU3E</b>	<b>S-1014PU3E</b>
Air flow	Hi / Med / Lo m <sup>3</sup> /min	22,0/16,0/13,0	36,0/26,0/18,0	37,0/27,0/19,0	38,0/29,0/20,0
Moisture removal volume	L/h	2,5	1,9	4,8	4,9
Sound pressure <sup>5)</sup>	Hi / Med / Lo dB(A)	37/31/28	45/38/32	46/39/33	47/40/34
Sound power	Hi / Med / Lo dB(A)	52/46/43	60/53/47	61/54/48	62/55/49
Dimension	Indoor (HxWxD) mm	256 x 840 x 840	319 x 840 x 840	319 x 840 x 840	319 x 840 x 840
	Panel (HxWxD) mm	33,5 x 950 x 950	33,5 x 950 x 950	33,5 x 950 x 950	33,5 x 950 x 950
Net weight	Indoor / Panel kg	20/5	25/5	25/5	25/5
nanoe X Generator		Mark 1	Mark 1	Mark 1	Mark 1
<b>Outdoor unit</b>		<b>U-71PZH4E8</b>	<b>U-100PZH4E8</b>	<b>U-125PZH4E8</b>	<b>U-140PZH4E8</b>
Power supply	V	380-400-415	380-400-415	380-400-415	380-400-415
Current	Cool A	2,95-2,80-2,70	3,60-3,40-3,25	5,45-5,15-5,00	6,15-5,85-5,65
	Heat A	3,15-3,00-2,90	3,75-3,55-3,40	5,10-4,80-4,65	6,20-5,90-5,65
Air flow	Cool / Heat m <sup>3</sup> /min	62,0/66,0	76,0/70,0	86,0/78,0	89,0/83,0
Sound pressure	Cool / Heat (Hi) dB(A)	48/50	52/52	55/55	56/56
Sound power	Cool / Heat (Hi) dB(A)	65/67	69/69	73/73	74/74
Dimension	HxWxD mm	996 x 980 x 370	996 x 980 x 370	996 x 980 x 370	996 x 980 x 370
Net weight	kg	66	82	84	84
Piping diameter	Liquid Inch (mm)	3/8 (9,52)	3/8 (9,52)	3/8 (9,52)	3/8 (9,52)
	Gas Inch (mm)	5/8 (15,88)	5/8 (15,88)	5/8 (15,88)	5/8 (15,88)
Pipe length range	m	5-60	5-100	5-100	5-100
Elevation difference (in / out) <sup>8)</sup>	m	15/30	15/30	15/30	15/30
Pre-charged pipe length	m	30	30	30	30
Additional gas amount	g/m	30	40	40	40
Refrigerant (R32) / CO <sub>2</sub> Eq.	kg / T	1,95/1,32	2,70/1,82	3,00/2,03	3,00/2,03
Operating range	Cool Min ~ Max °C	-15 ~ +52	-20 <sup>9)</sup> ~ +52	-20 <sup>9)</sup> ~ +52	-20 <sup>9)</sup> ~ +52
	Heat Min ~ Max °C	-20 ~ +24	-20 ~ +24	-20 ~ +24	-20 ~ +24

1) EER and COP calculation is based in accordance to EN 14511. 2) For models below 12 kW, the SEER and SCOP is calculated based on values of EU/626/2011. For models above 12 kW, the η<sub>sc</sub> / η<sub>sh</sub> values is calculated based on EN 14825. 3) Factory setting. 4) The value is based on the interpolation. 5) The sound pressure of the units shows the value measured of the position 1,5 m below the unit. The sound pressure is measured in accordance with Eurovent 6/C/006-97 specification. 6) Connect the liquid socket tube (Ø6,35-Ø9,52) to the liquid tubing side indoor unit. 7) Connect the gas socket tube (Ø12,70-Ø15,88) to the gas tubing side indoor unit. 8) Outdoor unit located lower / outdoor unit located higher. 9) Pipe length up to 30 m. \*Recommended fuse for the indoor 3 A. \*\*Above values are in the case of nanoe™ X OFF.

Accessories	
<b>CZ-RTC6W</b>	CONEX wired remote controller (non-wireless), white
<b>CZ-RTC6WBL</b>	CONEX wired remote controller with Bluetooth®, white
<b>CZ-RTC6WBLW2</b>	CONEX wired remote controller with Wi-Fi and Bluetooth®, white
<b>CZ-RTC6</b>	CONEX wired remote controller (non-wireless), black
<b>CZ-RTC6BL</b>	CONEX wired remote controller with Bluetooth®, black
<b>CZ-RTC6BLW2</b>	CONEX wired remote controller with Wi-Fi and Bluetooth®, black
<b>CZ-RTC5B</b>	Wired remote controller with Econavi function
<b>CZ-RWS3 + CZ-RWRU3</b>	Infrared remote controller and receiver
<b>CZ-CAPWFC2</b>	Commercial Wi-Fi Adaptor

Accessories	
<b>CZ-KPU3A</b>	Econavi exclusive panel, white (RAL9003)
<b>CZ-KPU3B</b>	NEW Standard panel, graphite black (RAL9011)
<b>PAW-PACR4</b>	Interface to run up to 4 indoor unit groups on backup and alternative run
<b>PAW-WTRAY</b>	Tray for condenser water compatible with outdoor elevation platform
<b>PAW-GRDBSE20</b>	Outdoor base ground support for noise and vibration absorption
<b>PAW-GRDSTD40</b>	Outdoor elevation platform 400 x 900 x 400 mm
<b>CZ-FDU3+CZ-ATU2</b>	Fresh air-intake kit



SEER and SCOP: For S-3650PU3E + U-36PZH3E5. ECONAVI and INTERNET CONTROL: Optional.

Rating conditions: Cooling indoor 27 °C DB / 19 °C WB. Cooling outdoor 35 °C DB / 24 °C WB. Heating indoor 20 °C DB. Heating outdoor 7 °C DB / 6 °C WB. IDB: Dry Bulb; WB: Wet Bulb. Specifications subject to change without notice. For detailed information about ERP / Energy Labelling, please visit our websites www.aircon.panasonic.eu or www.ptc.panasonic.eu.

## PACi NX Series Standard 4 way 90x90 cassette - PU3 - R32

## 4 way 90x90 cassette - PU3.

Powerful turbo fan and intelligent Econavi sensor ensure high energy efficiency, and nanoe™ X, which is equipped as standard, provides an exceptional level of indoor air quality.



**nanoe™ X**  
nanoe™ X as a standard.

		Single phase						
		3,6 kW	5,0 kW	6,0 kW	7,1 kW	10,0 kW	12,5 kW	14,0 kW
Kit		KIT-36PU3Z5	KIT-50PU3Z5	KIT-60PU3Z5	KIT-71PU3Z5	KIT-100PU3Z5	KIT-125PU3Z5	KIT-140PU3Z5
Remote controller		CZ-RTC5B	CZ-RTC5B	CZ-RTC5B	CZ-RTC5B	CZ-RTC5B	CZ-RTC5B	CZ-RTC5B
Cooling capacity	Nom (Min - Max) kW	3,6(1,5 - 4,0)	5,0(1,5 - 5,6)	6,0(2,0 - 7,1)	7,1(2,6 - 7,7)	10,0(3,0 - 11,5)	12,5(3,2 - 13,5)	14,0(3,3 - 15,0)
EER <sup>1)</sup>	Nom (Min - Max) W/W	4,34(5,88-3,81)	3,91(6,25-3,20)	3,73(6,90-3,01)	3,27(5,00-2,77)	3,82(2,88-5,36)	3,58(2,81-5,33)	3,23(2,73-5,32)
<b>SEER / η<sub>sc</sub> <sup>2)</sup></b>		<b>8,1 A++</b>	<b>8,0 A++</b>	<b>7,8 A++</b>	<b>6,8 A++</b>	<b>6,8 A++</b>	<b>267,0%</b>	<b>257,0%</b>
Pdesign	kW	3,6	5,0	6,0	7,1	10,0	12,5	14,0
Input power	Nom (Min - Max) kW	0,83(0,25-1,05)	1,28(0,24-1,75)	1,61(0,29-2,36)	2,17(0,52-2,78)	2,62(0,56-4,00)	3,49(0,60-4,80)	4,34(0,62-5,50)
Annual energy consumption <sup>3)</sup>	kWh/a	156	219	269	365	515	—	—
Heating capacity	Nom (Min - Max) kW	3,6(1,5 - 4,6)	5,0(1,5 - 6,4)	6,0(1,8 - 7,0)	7,1(2,1 - 8,1)	10,0(3,0 - 14,0)	12,5(3,3 - 15,0)	14,0(3,4 - 16,0)
Heating capacity at -15 °C <sup>4)</sup>	Max kW	2,7	3,7	4,7	4,8	8,2	10,5	10,8
COP <sup>1)</sup>	Nom (Min - Max) W/W	5,07(4,32-6,52)	4,63(3,48-7,50)	4,48(3,18-7,50)	4,23(3,38-6,36)	4,93(3,59-5,36)	4,43(3,57-5,50)	4,18(3,33-5,48)
<b>SCOP / η<sub>h</sub> <sup>2)</sup></b>		<b>4,8 A++</b>	<b>4,7 A++</b>	<b>4,9 A++</b>	<b>4,6 A++</b>	<b>4,4 A+</b>	<b>157,0%</b>	<b>152,2%</b>
Pdesign at -10 °C	kW	2,8	4,0	4,6	5,2	10,0	12,5	14,0 (at -7 °C)
Input power	Nom (Min - Max) kW	0,71(0,23-1,06)	1,08(0,20-1,84)	1,34(0,24-2,20)	1,68(0,33-2,40)	2,03(0,56-3,90)	2,82(0,60-4,20)	3,35(0,62-4,80)
Annual energy consumption <sup>3)</sup>	kWh/a	817	1191	1314	1583	3182	—	—
<b>Indoor unit</b>		<b>S-3650PU3E</b>	<b>S-3650PU3E</b>	<b>S-6071PU3E</b>	<b>S-6071PU3E</b>	<b>S-1014PU3E</b>	<b>S-1014PU3E</b>	<b>S-1014PU3E</b>
Air flow	Hi / Med / Lo m <sup>3</sup> /min	14,5/13,0/11,5	16,5/13,5/11,5	21,0/16,0/13,0	22,0/16,0/13,0	36,0/26,0/18,0	37,0/27,0/19,0	38,0/29,0/20,0
Moisture removal volume	L/h	0,7	1,6	1,7	2,5	4,8	4,8	6,0
Sound pressure <sup>5)</sup>	Hi / Med / Lo dB(A)	30/28/27	32/29/27	36/31/28	37/31/28	45/38/32	46/39/33	47/40/34
Sound power	Hi / Med / Lo dB(A)	45/43/42	47/44/42	51/46/43	52/46/43	60/53/47	61/54/48	62/55/49
Dimension	Indoor (HxWxD) mm	256x840x840	256x840x840	256x840x840	256x840x840	319x840x840	319x840x840	319x840x840
	Panel (HxWxD) mm	33,5x950x950	33,5x950x950	33,5x950x950	33,5x950x950	33,5x950x950	33,5x950x950	33,5x950x950
Net weight	Indoor / Panel kg	19/5	19/5	20/5	20/5	25/5	25/5	25/5
nanoe X Generator		Mark 1	Mark 1	Mark 1	Mark 1	Mark 1	Mark 1	Mark 1
<b>Outdoor unit</b>		<b>U-36PZ3E5</b>	<b>U-50PZ3E5</b>	<b>U-60PZ3E5A</b>	<b>U-71PZ3E5A</b>	<b>U-100PZ3E5</b>	<b>U-125PZ3E5</b>	<b>U-140PZ3E5</b>
Power supply	V	220-230-240	220-230-240	220-230-240	220-230-240	220-230-240	220-230-240	220-230-240
Current	Cool A	3,85-3,70-3,55	5,95-5,70-5,45	7,45-7,15-6,85	10,00-9,65-9,25	13,10-12,50-12,00	16,90-16,10-15,40	21,00-20,00-19,20
	Heat A	3,35-3,20-3,05	5,05-4,85-4,65	6,20-5,95-5,70	7,80-7,45-7,15	10,10-9,70-9,30	13,60-13,00-12,50	16,20-15,50-14,80
Air flow	Cool / Heat m <sup>3</sup> /min	33,6/34,0	32,7/31,9	42,6/41,5	44,7/45,9	73,0/73,0	82,0/80,0	84,0/82,0
Sound pressure	Cool / Heat (Hi) dB(A)	46/47	46/46	47/48	48/49	52/52	55/55	56/56
Sound power	Cool / Heat (Hi) dB(A)	64/66	64/64	64/65	66/68	70/70	73/73	74/74
Dimension	HxWxD mm	619x824x299	619x824x299	695x875x320	695x875x320	996x980x370	996x980x370	996x980x370
Net weight	kg	32	35	42	50	83	87	87
Piping diameter	Liquid Inch (mm)	1/4(6,35)	1/4(6,35)	1/4(6,35) <sup>6)</sup>	1/4(6,35) <sup>6)</sup>	3/8(9,52)	3/8(9,52)	3/8(9,52)
	Gas Inch (mm)	1/2(12,70)	1/2(12,70)	1/2(12,70) <sup>7)</sup>	5/8(15,88)	5/8(15,88)	5/8(15,88)	5/8(15,88)
Pipe length range	m	3-15	3-20	3-40	3-40	5-50	5-50	5-50
Elevation difference (in / out) <sup>8)</sup>	m	15/15	15/15	15/30	20/30	15/30	15/30	15/30
Pre-charged pipe length	m	7,5	7,5	30	30	30	30	30
Additional gas amount	g/m	10	15	15	17	45	45	45
Refrigerant (R32) / CO <sub>2</sub> Eq.	kg / T	0,87/0,59	1,14/0,77	1,15/0,78	1,32/0,89	2,40/1,62	2,80/1,89	2,80/1,89
Operating range	Cool Min ~ Max °C	-10~+43	-10~+43	-10~+43	-10~+43	-10~+43	-10~+43	-10~+43
	Heat Min ~ Max °C	-15~+24	-15~+24	-15~+24	-15~+24	-15~+24	-15~+24	-15~+24

## Technical focus

- High performance turbo fan
- Econavi: An optional intelligent sensor to reduce waste of energy
- nanoe™ X (Generator Mark 1: 4,8 trillion hydroxyl radicals/sec) as standard for better indoor air quality, indoor unit internal cleaning with nanoe™ X plus dry operation
- New graphite black and white panels providing options to suit a variety of light commercial applications
- Lower noise in low fan operation
- Light weight, easy piping and integrated drain pump for quick installation
- Wired remote control CZ-RTC6WBL and CZ-RTC6BL allows easy system setting via Bluetooth®
- High volume fresh air input with optional air-intake plenum and chamber (CZ-FDU3+CZ-ATU2)

## White and graphite black panels available for the 4 way 90x90 cassette.

Standard panel, white (RAL9003).  
CZ-KPU3



Econavi panel, white (RAL9003).  
CZ-KPU3A

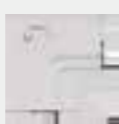

Standard panel, graphite black (RAL9011).  
CZ-KPU3B



COMPATIBLE WITH ALL PANASONIC CONNECTIVITY SOLUTIONS. FOR DETAILED INFORMATION GO TO THE CONTROL SYSTEMS SECTION

## Optional:



		Three phase		
		10,0 kW	12,5 kW	14,0 kW
Kit		KIT-100PU3Z8	KIT-125PU3Z8	KIT-140PU3Z8
Remote controller		CZ-RTC5B	CZ-RTC5B	CZ-RTC5B
Cooling capacity	Nominal (Min - Max) kW	10,0(3,0 - 11,5)	12,5(3,2 - 13,5)	14,0(3,3 - 15,0)
EER <sup>1)</sup>	Nominal (Min - Max) W/W	3,82(2,88-5,36)	3,58(2,81-5,33)	3,23(2,73-5,32)
<b>SEER / η<sub>sc</sub> <sup>2)</sup></b>		<b>6,7 A++</b>	<b>265,8%</b>	<b>256,2%</b>
Pdesign	kW	10,0	12,5	14,0
Input power	Nominal (Min - Max) kW	2,62(0,56-4,00)	3,49(0,60-4,80)	4,34(0,62-5,50)
Annual energy consumption <sup>3)</sup>	kWh/a	521	—	—
Heating capacity	Nominal (Min - Max) kW	10,0(3,0 - 14,0)	12,5(3,3 - 15,0)	14,0(3,4 - 16,0)
Heating capacity at -15 °C <sup>4)</sup>	Max kW	8,2	10,5	10,8
COP <sup>1)</sup>	Nominal (Min - Max) W/W	4,93(3,59-5,36)	4,43(3,57-5,50)	4,18(3,33-5,48)
<b>SCOP / η<sub>h</sub> <sup>2)</sup></b>		<b>4,4 A+</b>	<b>157,0%</b>	<b>152,2%</b>
Pdesign at -10 °C	kW	10,0	12,5	14,0 (at -7 °C)
Input power	Nominal (Min - Max) kW	2,03(0,56-3,90)	2,82(0,60-4,20)	3,35(0,62-4,80)
Annual energy consumption <sup>3)</sup>	kWh/a	3182	—	—
<b>Indoor unit</b>		<b>S-1014PU3E</b>	<b>S-1014PU3E</b>	<b>S-1014PU3E</b>
Air flow	Hi / Med / Lo m <sup>3</sup> /min	36,0/26,0/18,0	37,0/27,0/19,0	38,0/29,0/20,0
Moisture removal volume	L/h	2,7	4,8	6,0
Sound pressure <sup>5)</sup>	Hi / Med / Lo dB(A)	45/38/32	46/39/33	47/40/34
Sound power	Hi / Med / Lo dB(A)	60/53/47	61/54/48	62/55/49
Dimension	Indoor (HxWxD) mm	319 x 840 x 840	319 x 840 x 840	319 x 840 x 840
	Panel (HxWxD) mm	33,5 x 950 x 950	33,5 x 950 x 950	33,5 x 950 x 950
Net weight	Indoor / Panel kg	25/5	25/5	25/5
nanoe X Generator		Mark 1	Mark 1	Mark 1
<b>Outdoor unit</b>		<b>U-100PZ3E8</b>	<b>U-125PZ3E8</b>	<b>U-140PZ3E8</b>
Power supply	V	380-400-415	380-400-415	380-400-415
Current	Cool A	4,35-4,15-4,00	5,65-5,35-5,15	7,00-6,65-6,40
	Heat A	3,40-3,20-3,10	4,55-4,35-4,15	5,40-5,15-4,95
Air flow	Cool / Heat m <sup>3</sup> /min	73,0/73,0	82,0/80,0	84,0/82,0
Sound pressure	Cool / Heat (Hi) dB(A)	52/52	55/55	56/56
Sound power	Cool / Heat (Hi) dB(A)	70/70	73/73	74/74
Dimension	HxWxD mm	996x980x370	996x980x370	996x980x370
Net weight	kg	83	87	87
Piping diameter	Liquid Inch (mm)	3/8(9,52)	3/8(9,52)	3/8(9,52)
	Gas Inch (mm)	5/8(15,88)	5/8(15,88)	5/8(15,88)
Pipe length range	m	5-50	5-50	5-50
Elevation difference (in / out) <sup>8)</sup>	m	15/30	15/30	15/30
Pre-charged pipe length	m	30	30	30
Additional gas amount	g/m	45	45	45
Refrigerant (R32) / CO <sub>2</sub> Eq.	kg / T	2,40/1,62	2,80/1,89	2,80/1,89
Operating range	Cool Min ~ Max °C	-10~+43	-10~+43	-10~+43
	Heat Min ~ Max °C	-15~+24	-15~+24	-15~+24

<sup>1)</sup> EER and COP calculation is based in accordance to EN 14511. <sup>2)</sup> For models above 12 kW, the SEER and SCOP is calculated based on values of EU/626/2011. For models above 12 kW, the η<sub>sc</sub> / η<sub>h</sub> values is calculated based on EN 14825. <sup>3)</sup> Factory setting. <sup>4)</sup> The value is based on the interpolation. <sup>5)</sup> The sound pressure of the units shows the value measured of the position 1,5 m below the unit. The sound pressure is measured in accordance with Eurovent 6/C/006-97 specification. <sup>6)</sup> Connect the liquid socket tube (Ø6,35-Ø9,52) to the liquid tubing side indoor unit. <sup>7)</sup> Connect the gas socket tube (Ø12,70-Ø15,88) to the gas tubing side indoor unit. <sup>8)</sup> Outdoor unit located lower / outdoor unit located higher. \*Recommended fuse for the indoor 3 A. \*\*Above values are in the case of nanoe™ X OFF.

Accessories	
<b>CZ-RTC6W</b>	CONEX wired remote controller (non-wireless), white
<b>CZ-RTC6WBL</b>	CONEX wired remote controller with Bluetooth®, white
<b>CZ-RTC6WBLW2</b>	CONEX wired remote controller with Wi-Fi and Bluetooth®, white
<b>CZ-RTC6</b>	CONEX wired remote controller (non-wireless), black
<b>CZ-RTC6BL</b>	CONEX wired remote controller with Bluetooth®, black
<b>CZ-RTC6BLW2</b>	CONEX wired remote controller with Wi-Fi and Bluetooth®, black
<b>CZ-RTC5B</b>	Wired remote controller with Econavi function
<b>CZ-RWS3 + CZ-RWRU3</b>	Infrared remote controller and receiver
<b>CZ-CAPWFC2</b>	Commercial Wi-Fi Adaptor

Accessories	
<b>CZ-KPU3A</b>	Econavi exclusive panel, white (RAL9003)
<b>CZ-KPU3B</b>	NEW Standard panel, graphite black (RAL9011)
<b>PAW-PACR4</b>	Interface to run up to 4 indoor unit groups on backup and alternative run
<b>PAW-WTRAY</b>	Tray for condenser water compatible with outdoor elevation platform
<b>PAW-GRDBSE20</b>	Outdoor base ground support for noise and vibration absorption
<b>PAW-GRDSTD40</b>	Outdoor elevation platform 400x900x400 mm
<b>CZ-FDU3+CZ-ATU2</b>	Fresh air-intake kit



SEER: For S-3650PU3E + U-36PZ3E5. SCOP: For S-6071PU3E + U-60PZ3E5A. ECONAVI and INTERNET CONTROL: Optional.

Rating conditions: Cooling indoor 27 °C DB / 19 °C WB. Cooling outdoor 35 °C DB / 24 °C WB. Heating indoor 20 °C DB. Heating outdoor 7 °C DB / 6 °C WB. IDB: Dry Bulb; WB: Wet Bulb. Specifications subject to change without notice. For detailed information about ERP / Energy Labelling, please visit our websites www.aircon.panasonic.eu or www.ptc.panasonic.eu.

## PACi NX Series Elite ceiling - PT3 - R32

Ceiling mounted units provide large and wide air distribution which is ideal for large rooms.

The height and depth of all capacities are the same for unified appearance in mixed installations.



**nanoe™ X**  
nanoe™ X as a standard.

		Single phase							
		3,6 kW	5,0 kW	6,0 kW	7,1 kW	10,0 kW	12,5 kW	14,0 kW	
Kit		KIT-36PT3ZH5	KIT-50PT3ZH5	KIT-60PT3ZH5	KIT-71PT3ZH45	KIT-100PT3ZH45	KIT-125PT3ZH45	KIT-140PT3ZH45	
Remote controller		CZ-RTC5B	CZ-RTC5B	CZ-RTC5B	CZ-RTC5B	CZ-RTC5B	CZ-RTC5B	CZ-RTC5B	
Cooling capacity	Nom (Min - Max) kW	3,5(1,2 - 4,0)	5,0(1,2 - 5,6)	6,0(1,2 - 7,1)	6,8(2,2 - 9,0)	9,5(3,1 - 12,5)	12,1(3,2 - 14,0)	13,4(3,3 - 16,0)	
EER <sup>1)</sup>	Nom (Min - Max) W/W	4,86(4,55 - 5,45)	4,03(3,57 - 5,45)	3,82(3,02 - 5,45)	3,91(2,69 - 5,79)	4,06(3,29 - 5,34)	3,46(3,01 - 5,33)	3,21(2,67 - 5,32)	
<b>SEER / η<sub>sc</sub><sup>2)</sup></b>		<b>7,7 A++</b>	<b>7,4 A++</b>	<b>7,5 A++</b>	<b>7,3 A++</b>	<b>7,3 A++</b>	<b>278,4%</b>	<b>263,3%</b>	
Pdesign	kW	3,5	5,0	6,0	6,8	9,5	12,1	13,4	
Input power	Nom (Min - Max) kW	0,72(0,22 - 0,88)	1,24(0,22 - 1,57)	1,57(0,22 - 2,35)	1,74(0,38 - 3,35)	2,34(0,58 - 3,80)	3,50(0,60 - 4,65)	4,17(0,62 - 6,00)	
Annual energy consumption <sup>3)</sup>	kWh/a	160	237	280	326	456	—	—	
Heating capacity	Nom (Min - Max) kW	4,0(1,2 - 5,0)	5,6(1,2 - 6,5)	7,0(1,2 - 8,0)	8,0(2,0 - 9,0)	11,2(3,1 - 14,0)	14,0(3,2 - 16,0)	16,0(3,3 - 18,0)	
Heating capacity at -15 °C <sup>4)</sup>	Max kW	3,2	4,1	5,1	7,5	11,9	13,4	15,0	
COP <sup>1)</sup>	Nom (Min - Max) W/W	5,00(4,17 - 5,45)	4,03(3,94 - 5,45)	4,14(3,40 - 5,45)	3,96(3,16 - 5,56)	4,00(3,54 - 5,54)	3,78(3,20 - 5,52)	3,38(3,10 - 5,50)	
<b>SCOP / η<sub>sh</sub><sup>2)</sup></b>		<b>4,9 A++</b>	<b>4,8 A++</b>	<b>4,8 A++</b>	<b>4,7 A++</b>	<b>4,5 A+</b>	<b>175,6%</b>	<b>169,3%</b>	
Pdesign at -10 °C	kW	3,1	4,0	4,6	4,7	7,8	9,5	10,2	
Input power	Nom (Min - Max) kW	0,80(0,22 - 1,20)	1,39(0,22 - 1,65)	1,69(0,22 - 2,35)	2,02(0,36 - 2,85)	2,80(0,56 - 3,95)	3,70(0,58 - 5,00)	4,74(0,60 - 5,80)	
Annual energy consumption <sup>3)</sup>	kWh/a	886	1167	1342	1400	2426	—	—	
Indoor unit		S-3650PT3E	S-3650PT3E	S-6071PT3E	S-6071PT3E	S-1014PT3E	S-1014PT3E	S-1014PT3E	
Air flow	Hi / Med / Lo m <sup>3</sup> /min	14,0/12,0/10,5	15,0/12,5/10,5	20,0/17,0/14,5	21,0/18,0/15,5	30,0/25,0/23,0	34,0/28,0/24,0	35,0/29,0/25,0	
Moisture removal volume	L/h	0,8	2,0	2,1	2,7	3,6	5,4	6,4	
Sound pressure <sup>5)</sup>	Hi / Med / Lo dB(A)	36/32/28	37/33/28	38/34/29	39/35/30	42/37/34	46/40/35	47/41/36	
Sound power	Hi / Med / Lo dB(A)	54/50/46	55/51/46	56/52/47	57/53/48	60/55/52	64/58/53	65/59/54	
Dimension	H x W x D mm	235 x 960 x 690	235 x 960 x 690	235 x 1275 x 690	235 x 1275 x 690	235 x 1590 x 690	235 x 1590 x 690	235 x 1590 x 690	
Net weight	kg	26	26	34	34	40	40	40	
nanoe X Generator		Mark 2	Mark 2	Mark 2	Mark 2	Mark 2	Mark 2	Mark 2	
Outdoor unit		U-36PZH3E5	U-50PZH3E5	U-60PZH3E5	U-71PZH4E5	U-100PZH4E5	U-125PZH4E5	U-140PZH4E5	
Power supply	V	220 - 230 - 240	220 - 230 - 240	220 - 230 - 240	220 - 230 - 240	220 - 230 - 240	220 - 230 - 240	220 - 230 - 240	
Current	Cool A	3,55 - 3,40 - 3,25	5,85 - 5,60 - 5,40	7,35 - 7,05 - 6,75	8,80 - 8,40 - 8,05	11,60 - 11,10 - 10,60	17,10 - 16,40 - 15,70	20,40 - 19,50 - 18,70	
	Heat A	3,90 - 3,75 - 3,60	6,60 - 6,30 - 6,05	7,85 - 7,50 - 7,20	10,20 - 9,75 - 9,35	13,70 - 13,20 - 12,70	18,10 - 17,30 - 16,60	23,20 - 22,20 - 21,20	
Air flow	Cool / Heat m <sup>3</sup> /min	34,1/36,4	42,0/42,0	42,0/42,0	62,0/66,0	76,0/70,0	86,0/78,0	89,0/83,0	
Sound pressure	Cool / Heat (Hi) dB(A)	43/44	46/48	47/50	48/50	52/52	55/55	56/56	
Sound power	Cool / Heat (Hi) dB(A)	62/64	64/67	65/69	65/67	69/69	73/73	74/74	
Dimension	H x W x D mm	695 x 875 x 320	695 x 875 x 320	695 x 875 x 320	996 x 980 x 370	996 x 980 x 370	996 x 980 x 370	996 x 980 x 370	
Net weight	kg	42	42	43	66	84	86	86	
Piping diameter	Liquid Inch (mm)	1/4 (6,35)	1/4 (6,35)	1/4 (6,35) <sup>6)</sup>	3/8 (9,52)	3/8 (9,52)	3/8 (9,52)	3/8 (9,52)	
	Gas Inch (mm)	1/2 (12,70)	1/2 (12,70)	1/2 (12,70) <sup>7)</sup>	5/8 (15,88)	5/8 (15,88)	5/8 (15,88)	5/8 (15,88)	
Pipe length range	m	3 - 40	3 - 40	3 - 40	5 - 60	5 - 100	5 - 100	5 - 100	
Elevation difference (in / out) <sup>8)</sup>	m	15/30	15/30	15/30	15/30	15/30	15/30	15/30	
Pre-charged pipe length	m	30	30	30	30	30	30	30	
Additional gas amount	g/m	15	15	15	30	40	40	40	
Refrigerant [R32] / CO <sub>2</sub> Eq.	kg / T	1,13/0,76	1,13/0,76	1,15/0,78	1,95/1,32	2,70/1,82	3,00/2,03	3,00/2,03	
Operating range	Cool Min - Max °C	-15 ~ +46	-15 ~ +46	-15 ~ +46	-15 ~ +52	-20 <sup>9)</sup> ~ +52	-20 <sup>9)</sup> ~ +52	-20 <sup>9)</sup> ~ +52	
	Heat Min - Max °C	-20 ~ +24	-20 ~ +24	-20 ~ +24	-20 ~ +24	-20 ~ +24	-20 ~ +24	-20 ~ +24	

## Technical focus

- Wide air distribution for large rooms
- Horizontal air flow reaches maximum 9,5 m
- Fresh air connection available on the unit
- Slim design with 235 mm height fits narrow space
- Silent operation
- nanoe™ X (Generator Mark 2: 9,6 trillion hydroxyl radicals/sec) as standard for better indoor air quality
- Wired remote control CZ-RTC6WBL and CZ-RTC6BL allows easy system setting via Bluetooth®
- Twin, Triple and Double-twin split options
- Easy connection and control of external fan or ERV using the connector PAW-FDC on the indoor unit PCB. The external device can be controlled by the remote control of the Panasonic indoor unit

## Further comfort improvement with air flow distribution

Horizontal air flow reaches maximum 9,5 m. This is ideal for wide rooms.

The wide air discharge opening expands the air flow to the left and right. The unpleasant feeling caused when the air flow directly hits the human body is prevented by the "Draft prevention position", which changes the swing width, increasing the degree of comfort.



COMPATIBLE WITH ALL PANASONIC CONNECTIVITY SOLUTIONS. FOR DETAILED INFORMATION GO TO THE CONTROL SYSTEMS SECTION

Optional:

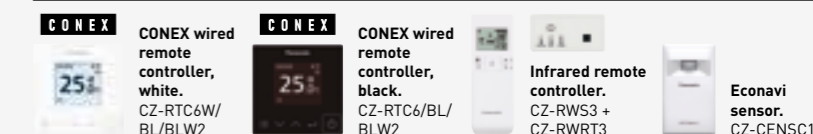

		Three phase			
		7,1 kW	10,0 kW	12,5 kW	14,0 kW
Kit		KIT-71PT3ZH48	KIT-100PT3ZH48	KIT-125PT3ZH48	KIT-140PT3ZH48
Remote controller		CZ-RTC5B	CZ-RTC5B	CZ-RTC5B	CZ-RTC5B
Cooling capacity	Nominal (Min - Max) kW	6,8(2,2 - 9,0)	9,5(3,1 - 12,5)	12,1(3,2 - 14,0)	13,4(3,3 - 16,0)
EER <sup>1)</sup>	Nominal (Min - Max) W/W	3,91(2,69 - 5,79)	4,06(3,29 - 5,34)	3,46(3,01 - 5,33)	3,21(2,67 - 5,32)
<b>SEER / η<sub>sc</sub><sup>2)</sup></b>		<b>7,2 A++</b>	<b>7,2 A++</b>	<b>277,3%</b>	<b>262,4%</b>
Pdesign	kW	6,8	9,5	12,1	13,4
Input power	Nominal (Min - Max) kW	1,74(0,38 - 3,35)	2,34(0,58 - 3,80)	3,50(0,60 - 4,65)	4,17(0,62 - 6,00)
Annual energy consumption <sup>3)</sup>	kWh/a	331	462	—	—
Heating capacity	Nominal (Min - Max) kW	8,0(2,0 - 9,0)	11,2(3,1 - 14,0)	14,0(3,2 - 16,0)	16,0(3,3 - 18,0)
Heating capacity at -15 °C <sup>4)</sup>	Max kW	7,5	11,9	13,4	15,0
COP <sup>1)</sup>	Nominal (Min - Max) W/W	3,96(3,16 - 5,56)	4,00(3,54 - 5,54)	3,78(3,20 - 5,52)	3,38(3,10 - 5,50)
<b>SCOP / η<sub>sh</sub><sup>2)</sup></b>		<b>4,7 A++</b>	<b>4,5 A+</b>	<b>175,6%</b>	<b>169,3%</b>
Pdesign at -10 °C	kW	4,7	7,8	9,5	10,2
Input power	Nominal (Min - Max) kW	2,02(0,36 - 2,85)	2,80(0,56 - 3,95)	3,70(0,58 - 5,00)	4,74(0,60 - 5,80)
Annual energy consumption <sup>3)</sup>	kWh/a	1400	2427	—	—
Indoor unit		S-6071PT3E	S-1014PT3E	S-1014PT3E	S-1014PT3E
Air flow	Hi / Med / Lo m <sup>3</sup> /min	21,0/18,0/15,5	30,0/25,0/23,0	34,0/28,0/24,0	35,0/29,0/25,0
Moisture removal volume	L/h	2,7	3,6	5,4	6,4
Sound pressure <sup>5)</sup>	Hi / Med / Lo dB(A)	39/35/30	42/37/34	46/40/35	47/41/36
Sound power	Hi / Med / Lo dB(A)	57/53/48	60/55/52	64/58/53	65/59/54
Dimension	H x W x D mm	235 x 1275 x 690	235 x 1590 x 690	235 x 1590 x 690	235 x 1590 x 690
Net weight	kg	34	40	40	40
nanoe X Generator		Mark 2	Mark 2	Mark 2	Mark 2
Outdoor unit		U-71PZH4E8	U-100PZH4E8	U-125PZH4E8	U-140PZH4E8
Power supply	V	380 - 400 - 415	380 - 400 - 415	380 - 400 - 415	380 - 400 - 415
Current	Cool A	2,95 - 2,80 - 2,70	3,60 - 3,40 - 3,25	5,45 - 5,15 - 5,00	6,15 - 5,85 - 5,65
	Heat A	3,15 - 3,00 - 2,90	3,75 - 3,55 - 3,40	5,10 - 4,80 - 4,65	6,20 - 5,90 - 5,65
Air flow	Cool / Heat m <sup>3</sup> /min	62,0/66,0	76,0/70,0	86,0/78,0	89,0/83,0
Sound pressure	Cool / Heat (Hi) dB(A)	48/50	52/52	55/55	56/56
Sound power	Cool / Heat (Hi) dB(A)	65/67	69/69	73/73	74/74
Dimension	H x W x D mm	996 x 980 x 370	996 x 980 x 370	996 x 980 x 370	996 x 980 x 370
Net weight	kg	66	82	84	84
Piping diameter	Liquid Inch (mm)	3/8 (9,52)	3/8 (9,52)	3/8 (9,52)	3/8 (9,52)
	Gas Inch (mm)	5/8 (15,88)	5/8 (15,88)	5/8 (15,88)	5/8 (15,88)
Pipe length range	m	5 - 60	5 - 100	5 - 100	5 - 100
Elevation difference (in / out) <sup>8)</sup>	m	15/30	15/30	15/30	15/30
Pre-charged pipe length	m	30	30	30	30
Additional gas amount	g/m	30	40	40	40
Refrigerant [R32] / CO <sub>2</sub> Eq.	kg / T	1,95/1,32	2,70/1,82	3,00/2,03	3,00/2,03
Operating range	Cool Min - Max °C	-15 ~ +52	-20 <sup>9)</sup> ~ +52	-20 <sup>9)</sup> ~ +52	-20 <sup>9)</sup> ~ +52
	Heat Min - Max °C	-20 ~ +24	-20 ~ +24	-20 ~ +24	-20 ~ +24

1) EER and COP calculation is based in accordance to EN 14511. 2) For models below 12 kW, the SEER and SCOP is calculated based on values of EU/626/2011. For models above 12 kW, the η<sub>sc</sub> / η<sub>sh</sub> values is calculated based on EN 14825. 3) Factory setting. 4) The value is based on the interpolation. 5) The sound pressure of the units shows the value measured of the position 1 m in front of the main body and 1 m below the unit. The sound pressure is measured in accordance with Eurovent 6/C/006-97 specification. 6) Connect the liquid socket tube (Ø6,35-Ø9,52) to the liquid tubing side indoor unit. 7) Connect the gas socket tube (Ø12,70-Ø15,88) to the gas tubing side indoor unit. 8) Outdoor unit located lower / outdoor unit located higher. 9) Pipe length up to 30 m. \*Recommended fuse for the indoor 3 A. \*\*Above values are in the case of nanoe™ X OFF.

Accessories	
<b>CZ-RTC6W</b>	CONEX wired remote controller (non-wireless), white
<b>CZ-RTC6WBL</b>	CONEX wired remote controller with Bluetooth®, white
<b>CZ-RTC6WBLW2</b>	CONEX wired remote controller with Wi-Fi and Bluetooth®, white
<b>CZ-RTC6</b>	CONEX wired remote controller (non-wireless), black
<b>CZ-RTC6BL</b>	CONEX wired remote controller with Bluetooth®, black
<b>CZ-RTC6BLW2</b>	CONEX wired remote controller with Wi-Fi and Bluetooth®, black
<b>CZ-RTC5B</b>	Wired remote controller with Econavi function
<b>CZ-RWS3 + CZ-RWRT3</b>	Infrared remote controller and receiver

Accessories	
<b>CZ-CAPWFC2</b>	Commercial Wi-Fi Adaptor
<b>PAW-PACR4</b>	Interface to run up to 4 indoor unit groups on backup and alternative run
<b>PAW-WTRAY</b>	Tray for condenser water compatible with outdoor elevation platform
<b>PAW-GRDBSE20</b>	Outdoor base ground support for noise and vibration absorption
<b>PAW-GRDSTD40</b>	Outdoor elevation platform 400 x 900 x 400 mm
<b>CZ-CENSC1</b>	Econavi energy saving sensor



SEER and SCOP: For S-3650PT3E + U-36PZH3E5. INTERNET CONTROL: Optional.

Rating conditions: Cooling indoor 27 °C DB / 19 °C WB. Cooling outdoor 35 °C DB / 24 °C WB. Heating indoor 20 °C DB. Heating outdoor 7 °C DB / 6 °C WB. IDB: Dry Bulb; WB: Wet Bulb. Specifications subject to change without notice. For detailed information about ERP / Energy Labelling, please visit our websites www.aircon.panasonic.eu or www.ptc.panasonic.eu.

**PACi NX Series Standard ceiling - PT3 - R32**

Ceiling mounted units provide large and wide air distribution which is ideal for large rooms.

The height and depth of all capacities are the same for unified appearance in mixed installations.



		Single phase						
		3,6 kW	5,0 kW	6,0 kW	7,1 kW	10,0 kW	12,5 kW	14,0 kW
Kit		KIT-36PT3Z5	KIT-50PT3Z5	KIT-60PT3Z5	KIT-71PT3Z5	KIT-100PT3Z5	KIT-125PT3Z5	KIT-140PT3Z5
Remote controller		CZ-RTC5B						
Cooling capacity	Nom (Min - Max) kW	3,5(1,5 - 4,0)	5,0(1,5 - 5,2)	6,0(2,0 - 7,1)	6,8(2,6 - 7,7)	10,0(3,0 - 11,5)	12,5(3,2 - 13,5)	14,0(3,3 - 15,0)
EER <sup>1)</sup>	Nom (Min - Max) W/W	4,14(3,69 - 5,17)	3,03(2,86 - 5,00)	3,59(2,90 - 6,90)	3,24(2,75 - 4,91)	3,64(2,80 - 5,36)	3,32(2,77 - 5,33)	2,98(2,73 - 5,32)
<b>SEER / η<sub>sc</sub> <sup>2)</sup></b>		<b>7,2 A++</b>	<b>6,7 A++</b>	<b>7,3 A++</b>	<b>5,9 A+</b>	<b>6,6 A++</b>	<b>241,7%</b>	<b>228,8%</b>
P <sub>design</sub>	kW	3,5	5,0	6,0	6,8	10,0	12,5	14,0
Input power	Nom (Min - Max) kW	0,85(0,29 - 1,10)	1,65(0,30 - 1,82)	1,67(0,29 - 2,45)	2,10(0,53 - 2,80)	2,75(0,56 - 4,10)	3,76(0,60 - 4,88)	4,70(0,62 - 5,50)
Annual energy consumption <sup>3)</sup>	kWh/a	171	262	288	404	531	—	—
Heating capacity	Nom (Min - Max) kW	3,5(1,5 - 4,6)	5,0(1,5 - 6,4)	6,0(1,8 - 7,0)	6,8(2,1 - 8,1)	10,0(3,0 - 14,0)	12,5(3,3 - 15,0)	14,0(3,4 - 16,0)
Heating capacity at -15 °C <sup>4)</sup>	Max kW	2,7	3,7	4,7	4,8	8,2	10,5	10,8
COP <sup>1)</sup>	Nom (Min - Max) W/W	4,61(3,51 - 5,70)	3,73(3,12 - 6,25)	4,11(2,92 - 6,67)	4,20(3,06 - 5,68)	4,24(3,30 - 5,36)	3,89(3,41 - 4,52)	3,70(3,08 - 5,48)
<b>SCOP / η<sub>sh</sub> <sup>2)</sup></b>		<b>4,4 A+</b>	<b>4,1 A+</b>	<b>4,6 A++</b>	<b>4,3 A+</b>	<b>4,2 A+</b>	<b>147,4%</b>	<b>145,3%</b>
P <sub>design</sub> at -10 °C	kW	2,8	4,0	4,6	4,7	10,0	12,5	13,6
Input power	Nom (Min - Max) kW	0,76(0,26 - 1,31)	1,34(0,24 - 2,05)	1,46(0,27 - 2,40)	1,62(0,37 - 2,65)	2,36(0,56 - 4,00)	3,21(0,73 - 4,40)	3,78(0,62 - 5,20)
Annual energy consumption <sup>3)</sup>	kWh/a	891	1365	1399	1529	3331	—	—
<b>Indoor unit</b>		<b>S-3650PT3E</b>	<b>S-3650PT3E</b>	<b>S-6071PT3E</b>	<b>S-6071PT3E</b>	<b>S-1014PT3E</b>	<b>S-1014PT3E</b>	<b>S-1014PT3E</b>
Air flow	Hi / Med / Lo m <sup>3</sup> /min	14,0/12,0/10,5	15,0/12,5/10,5	20,0/17,0/14,5	21,0/18,0/15,5	30,0/25,0/23,0	34,0/28,0/24,0	35,0/29,0/25,0
Moisture removal volume	L/h	0,8	2,0	2,1	2,7	4,1	5,7	6,9
Sound pressure <sup>5)</sup>	Hi / Med / Lo dB(A)	36/32/28	37/33/28	38/34/29	39/35/30	42/37/34	46/40/35	47/41/36
Sound power	Hi / Med / Lo dB(A)	54/50/46	55/51/46	56/52/47	57/53/48	60/55/52	64/58/53	65/59/54
Dimension	H x W x D mm	235 x 960 x 690	235 x 960 x 690	235 x 1275 x 690	235 x 1275 x 690	235 x 1590 x 690	235 x 1590 x 690	235 x 1590 x 690
Net weight	kg	26	26	34	34	40	40	40
nanoe X Generator		Mark 2	Mark 2	Mark 2	Mark 2	Mark 2	Mark 2	Mark 2
<b>Outdoor unit</b>		<b>U-36PZ3E5</b>	<b>U-50PZ3E5</b>	<b>U-60PZ3E5A</b>	<b>U-71PZ3E5A</b>	<b>U-100PZ3E5</b>	<b>U-125PZ3E5</b>	<b>U-140PZ3E5</b>
Power supply	V	220 - 230 - 240	220 - 230 - 240	220 - 230 - 240	220 - 230 - 240	220 - 230 - 240	220 - 230 - 240	220 - 230 - 240
Current	Cool A	3,90 - 3,75 - 3,60	7,65 - 7,30 - 7,00	7,75 - 7,40 - 7,10	9,75 - 9,30 - 8,95	13,70 - 13,10 - 12,60	18,20 - 17,40 - 16,70	22,70 - 21,70 - 20,80
	Heat A	3,55 - 3,40 - 3,25	6,30 - 6,00 - 5,75	6,75 - 6,50 - 6,20	7,50 - 7,20 - 6,90	11,80 - 11,30 - 10,80	15,50 - 14,80 - 14,20	18,30 - 17,50 - 16,80
Air flow	Cool / Heat m <sup>3</sup> /min	33,6/34,0	32,7/31,9	42,6/41,5	44,7/45,9	73,0/73,0	82,0/80,0	84,0/82,0
Sound pressure	Cool / Heat (Hi) dB(A)	46/47	46/46	47/48	48/49	52/52	55/55	56/56
Sound power	Cool / Heat (Hi) dB(A)	64/66	64/64	64/65	66/68	70/70	73/73	74/74
Dimension	H x W x D mm	619 x 824 x 299	619 x 824 x 299	695 x 875 x 320	695 x 875 x 320	996 x 980 x 370	996 x 980 x 370	996 x 980 x 370
Net weight	kg	32	35	42	50	83	87	87
Piping diameter	Liquid Inch (mm)	1/4 (6,35)	1/4 (6,35)	1/4 (6,35) <sup>6)</sup>	1/4 (6,35) <sup>6)</sup>	3/8 (9,52)	3/8 (9,52)	3/8 (9,52)
	Gas Inch (mm)	1/2 (12,70)	1/2 (12,70)	1/2 (12,70) <sup>7)</sup>	5/8 (15,88)	5/8 (15,88)	5/8 (15,88)	5/8 (15,88)
Pipe length range	m	3 - 15	3 - 20	3 - 40	3 - 40	5 - 50	5 - 50	5 - 50
Elevation difference (in / out) <sup>8)</sup>	m	15/15	15/15	15/30	20/30	15/30	15/30	15/30
Pre-charged pipe length	m	7,5	7,5	30	30	30	30	30
Additional gas amount	g/m	10	15	15	17	45	45	45
Refrigerant [R32] / CO <sub>2</sub> Eq.	kg / T	0,87/0,59	1,14/0,77	1,15/0,78	1,32/0,89	2,40/1,62	2,80/1,89	2,80/1,89
Operating range	Cool Min - Max °C	-10 ~ +43	-10 ~ +43	-10 ~ +43	-10 ~ +43	-10 ~ +43	-10 ~ +43	-10 ~ +43
	Heat Min - Max °C	-15 ~ +24	-15 ~ +24	-15 ~ +24	-15 ~ +24	-15 ~ +24	-15 ~ +24	-15 ~ +24

**Technical focus**

- Wide air distribution for large rooms
- Horizontal air flow reaches maximum 9,5 m
- Fresh air connection available on the unit
- Slim design with 235 mm height fits narrow space
- Silent operation
- nanoEX X (Generator Mark 2: 9,6 trillion hydroxyl radicals/sec) as standard for better indoor air quality
- Wired remote control CZ-RTC6WBL and CZ-RTC6BL allows easy system setting via Bluetooth®
- Single and Twin options
- Easy connection and control of external fan or ERV using the connector PAW-FDC on the indoor unit PCB. The external device can be controlled by the remote control of the Panasonic indoor unit

**Further comfort improvement with air flow distribution**

Horizontal air flow reaches maximum 9,5 m. This is ideal for wide rooms. The wide air discharge opening expands the air flow to the left and right. The unpleasant feeling caused when the air flow directly hits the human body is prevented by the "Draft prevention position", which changes the swing width, increasing the degree of comfort.



COMPATIBLE WITH ALL PANASONIC CONNECTIVITY SOLUTIONS. FOR DETAILED INFORMATION GO TO THE CONTROL SYSTEMS SECTION

**Optional:**

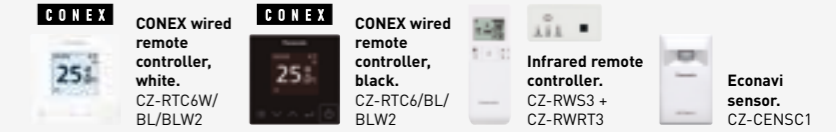

		Three phase		
		10,0 kW	12,5 kW	14,0 kW
Kit		KIT-100PT3Z8	KIT-125PT3Z8	KIT-140PT3Z8
Remote controller		CZ-RTC5B		
Cooling capacity	Nominal (Min - Max) kW	10,0(3,0 - 11,5)	12,5(3,2 - 13,5)	14,0(3,3 - 15,0)
EER <sup>1)</sup>	Nominal (Min - Max) W/W	3,64(3,50 - 5,36)	3,32(2,77 - 5,33)	2,98(2,73 - 5,32)
<b>SEER / η<sub>sc</sub> <sup>2)</sup></b>		<b>6,5 A++</b>	<b>241,7%</b>	<b>228,8%</b>
P <sub>design</sub>	kW	10,0	12,5	14,0
Input power	Nominal (Min - Max) kW	2,75(0,56 - 4,10)	3,76(0,60 - 4,88)	4,70(0,62 - 5,50)
Annual energy consumption <sup>3)</sup>	kWh/a	537	—	—
Heating capacity	Nominal (Min - Max) kW	10,0(3,0 - 14,0)	12,5(3,3 - 15,0)	14,0(3,4 - 16,0)
Heating capacity at -15 °C <sup>4)</sup>	Max kW	8,2	10,5	10,8
COP <sup>1)</sup>	Nominal (Min - Max) W/W	4,24(3,50 - 5,36)	3,89(3,41 - 4,52)	3,70(3,08 - 5,48)
<b>SCOP / η<sub>sh</sub> <sup>2)</sup></b>		<b>4,2 A+</b>	<b>147,4%</b>	<b>145,3%</b>
P <sub>design</sub> at -10 °C	kW	10,0	12,5	13,6
Input power	Nominal (Min - Max) kW	2,36(0,56 - 4,00)	3,21(0,73 - 4,40)	3,78(0,62 - 5,20)
Annual energy consumption <sup>3)</sup>	kWh/a	3331	—	—
<b>Indoor unit</b>		<b>S-1014PT3E</b>	<b>S-1014PT3E</b>	<b>S-1014PT3E</b>
Air flow	Hi / Med / Lo m <sup>3</sup> /min	30,0/25,0/23,0	34,0/28,0/24,0	35,0/29,0/25,0
Moisture removal volume	L/h	4,1	5,7	6,9
Sound pressure <sup>5)</sup>	Hi / Med / Lo dB(A)	42/37/34	46/40/35	47/41/36
Sound power	Hi / Med / Lo dB(A)	60/55/52	64/58/53	65/59/54
Dimension	H x W x D mm	235 x 1590 x 690	235 x 1590 x 690	235 x 1590 x 690
Net weight	kg	40	40	40
nanoe X Generator		Mark 2	Mark 2	Mark 2
<b>Outdoor unit</b>		<b>U-100PZ3E8</b>	<b>U-125PZ3E8</b>	<b>U-140PZ3E8</b>
Power supply	V	380 - 400 - 415	380 - 400 - 415	380 - 400 - 415
Current	Cool A	4,60 - 4,35 - 4,20	6,10 - 5,75 - 5,55	7,60 - 7,20 - 6,95
	Heat A	3,95 - 3,75 - 3,60	5,20 - 4,95 - 4,75	6,10 - 5,80 - 5,60
Air flow	Cool / Heat m <sup>3</sup> /min	73,0/73,0	82,0/80,0	84,0/82,0
Sound pressure	Cool / Heat (Hi) dB(A)	52/52	55/55	56/56
Sound power	Cool / Heat (Hi) dB(A)	70/70	73/73	74/74
Dimension	H x W x D mm	996 x 980 x 370	996 x 980 x 370	996 x 980 x 370
Net weight	kg	83	87	87
Piping diameter	Liquid Inch (mm)	3/8 (9,52)	3/8 (9,52)	3/8 (9,52)
	Gas Inch (mm)	5/8 (15,88)	5/8 (15,88)	5/8 (15,88)
Pipe length range	m	5 - 50	5 - 50	5 - 50
Elevation difference (in / out) <sup>8)</sup>	m	15/30	15/30	15/30
Pre-charged pipe length	m	30	30	30
Additional gas amount	g/m	45	45	45
Refrigerant [R32] / CO <sub>2</sub> Eq.	kg / T	2,40/1,62	2,8/1,89	2,8/1,89
Operating range	Cool Min - Max °C	-10 ~ +43	-10 ~ +43	-10 ~ +43
	Heat Min - Max °C	-15 ~ +24	-15 ~ +24	-15 ~ +24

1) EER and COP calculation is based in accordance to EN 14511. 2) For models below 12 kW, the SEER and SCOP is calculated based on values of EU/626/2011. For models above 12 kW, the η<sub>sc</sub> / η<sub>sh</sub> values is calculated based on EN 14825. 3) Factory setting. 4) The value is based on the interpolation. 5) The sound pressure of the units shows the value measured of the position 1 m in front of the main body and 1 m below the unit. The sound pressure is measured in accordance with Eurovent 6/C/006-97 specification. 6) Connect the liquid socket tube (Ø6,35-Ø9,52) to the liquid tubing side indoor unit. 7) Connect the gas socket tube (Ø12,70-Ø15,88) to the gas tubing side indoor unit. 8) Outdoor unit located lower / outdoor unit located higher. \*Recommended fuse for the indoor 3 A. \*\*Above values are in the case of nanoEX™ X OFF.

Accessories	
<b>CZ-RTC6W</b>	CONEX wired remote controller (non-wireless), white
<b>CZ-RTC6WBL</b>	CONEX wired remote controller with Bluetooth®, white
<b>CZ-RTC6WBLW2</b>	CONEX wired remote controller with Wi-Fi and Bluetooth®, white
<b>CZ-RTC6</b>	CONEX wired remote controller (non-wireless), black
<b>CZ-RTC6BL</b>	CONEX wired remote controller with Bluetooth®, black
<b>CZ-RTC6BLW2</b>	CONEX wired remote controller with Wi-Fi and Bluetooth®, black
<b>CZ-RTC5B</b>	Wired remote controller with Econavi function
<b>CZ-RWS3 + CZ-RWRT3</b>	Infrared remote controller and receiver

Accessories	
<b>CZ-CAPWFC2</b>	Commercial Wi-Fi Adaptor
<b>PAW-PACR4</b>	Interface to run up to 4 indoor unit groups on backup and alternative run
<b>PAW-WTRAY</b>	Tray for condenser water compatible with outdoor elevation platform
<b>PAW-GRDBSE20</b>	Outdoor base ground support for noise and vibration absorption
<b>PAW-GRDSTD40</b>	Outdoor elevation platform 400x900x400 mm
<b>CZ-CENSC1</b>	Econavi energy saving sensor



SEER and SCOP: For S-6071PT3E + U-60PZ3E5A. INTERNET CONTROL: Optional.

Rating conditions: Cooling indoor 27 °C DB / 19 °C WB. Cooling outdoor 35 °C DB / 24 °C WB. Heating indoor 20 °C DB. Heating outdoor 7 °C DB / 6 °C WB. IDB: Dry Bulb; WB: Wet Bulb. Specifications subject to change without notice. For detailed information about ErP / Energy Labelling, please visit our websites www.aircon.panasonic.eu or www.ptc.panasonic.eu.

## PACi NX Series Elite adaptive ducted unit - PF3 - R32

## Adaptive ducted unit - PF3.

2 installation possibilities (horizontal / vertical) with high ESP 150Pa allows flexible installation.



		Single phase						
		3,6 kW	5,0 kW	6,0 kW	7,1 kW	10,0 kW	12,5 kW	14,0 kW
Kit		KIT-36PF3ZH5	KIT-50PF3ZH5	KIT-60PF3ZH5	KIT-71PF3ZH45	KIT-100PF3ZH45	KIT-125PF3ZH45	KIT-140PF3ZH45
Remote controller		CZ-RTC5B	CZ-RTC5B	CZ-RTC5B	CZ-RTC5B	CZ-RTC5B	CZ-RTC5B	CZ-RTC5B
Cooling capacity	Nom (Min - Max) kW	3,6(1,2-4,0)	5,0(1,2-5,6)	5,7(1,2-6,3)	6,8(2,2-7,8)	9,5(3,1-11,4)	12,1(3,2-13,6)	13,4(3,3-15,3)
EER <sup>1)</sup>	Nom (Min - Max) W/W	4,24(3,57-5,45)	3,42(3,11-5,45)	3,68(3,15-5,45)	3,74(2,41-5,64)	4,09(2,82-5,08)	3,53(3,00-5,00)	3,38(2,59-4,18)
<b>SEER / η<sub>sc</sub><sup>2)</sup></b>		<b>6,8 A++</b>	<b>6,1 A++</b>	<b>7,1 A++</b>	<b>7,1 A++</b>	<b>7,4 A++</b>	<b>281,7%</b>	<b>275,9%</b>
P <sub>design</sub>	kW	3,6	5,0	5,7	6,8	9,5	12,1	13,4
Input power	Nom (Min - Max) kW	0,85(0,22-1,12)	1,46(0,22-1,80)	1,55(0,22-2,00)	1,82(0,39-3,24)	3,23(0,61-4,04)	3,43(0,64-4,54)	3,96(0,79-5,90)
Annual energy consumption <sup>3)</sup>	kWh/a	185	287	281	332	447	—	—
Heating capacity	Nom (Min - Max) kW	4,0(1,2-5,0)	5,6(1,2-6,5)	7,0(1,2-8,0)	7,5(2,0-9,0)	10,8(3,1-13,5)	13,5(3,2-15,4)	15,5(3,3-17,4)
Heating capacity at -15 °C <sup>4)</sup>	Max kW	3,2	4,1	5,1	7,5	11,5	12,9	14,5
COP <sup>1)</sup>	Nom (Min - Max) W/W	4,17(3,23-5,45)	3,61(2,97-5,45)	3,74(3,33-5,45)	4,03(3,16-5,41)	3,88(3,07-5,25)	3,46(3,06-5,16)	3,33(3,14-4,29)
<b>SCOP / η<sub>sh</sub><sup>2)</sup></b>		<b>4,5 A+</b>	<b>4,2 A+</b>	<b>4,4 A+</b>	<b>4,7 A++</b>	<b>4,3 A+</b>	<b>165,0%</b>	<b>162,6%</b>
P <sub>design</sub> at -10 °C	kW	3,6	4,0	4,7	4,7	7,8	9,3	9,5
Input power	Nom (Min - Max) kW	0,96(0,22-1,55)	1,55(0,22-2,19)	1,87(0,22-2,40)	1,86(0,37-2,85)	2,78(0,59-4,40)	3,90(0,62-5,04)	4,65(0,77-5,55)
Annual energy consumption <sup>3)</sup>	kWh/a	1120	1333	1495	1393	2540	—	—
<b>Indoor unit</b>		<b>S-3650PF3E</b>	<b>S-3650PF3E</b>	<b>S-6071PF3E</b>	<b>S-6071PF3E</b>	<b>S-1014PF3E</b>	<b>S-1014PF3E</b>	<b>S-1014PF3E</b>
External static pressure <sup>5)</sup>	Nom (Min - Max) Pa	30(10-150)	30(10-150)	30(10-150)	30(10-150)	40(10-150)	50(10-150)	50(10-150)
Air flow	Hi / Med / Lo m <sup>3</sup> /min	14,0/13,0/10,0	16,0/15,0/12,0	21,0/19,0/15,0	21,0/19,0/15,0	20,0/26,0/21,0	34,0/29,0/23,0	36,0/32,0/25,0
Moisture removal volume	L/h	0,9	1,9	1,7	2,7	3,2	4,1	4,9
Sound pressure <sup>6)</sup>	Hi / Med / Lo dB(A)	30/27/22	34/30/25	30/26/23	30/26/23	33/29/25	35/31/27	39/35/29
Sound power	Hi / Med / Lo dB(A)	53/50/45	57/53/48	53/49/46	53/49/46	56/52/48	58/54/50	62/58/52
Dimension	H x W x D mm	250 x 800 x 730	250 x 800 x 730	250 x 1000 x 730	250 x 1000 x 730	250 x 1400 x 730	250 x 1400 x 730	250 x 1400 x 730
Net weight	kg	25	25	30	30	39	39	39
nanoe X Generator		Mark 2	Mark 2	Mark 2	Mark 2	Mark 2	Mark 2	Mark 2
<b>Outdoor unit</b>		<b>U-36PZH3E5</b>	<b>U-50PZH3E5</b>	<b>U-60PZH3E5</b>	<b>U-71PZH4E5</b>	<b>U-100PZH4E5</b>	<b>U-125PZH4E5</b>	<b>U-140PZH4E5</b>
Power supply	V	220-230-240	220-230-240	220-230-240	220-230-240	220-230-240	220-230-240	220-230-240
Current	Cool A	4,20-4,00-3,85	6,90-6,60-6,35	7,25-6,95-6,65	9,20-8,80-8,45	11,50-11,00-10,50	16,80-16,00-15,40	19,40-18,50-17,70
	Heat A	4,70-4,50-4,30	7,35-7,00-6,75	8,65-8,30-7,95	9,40-9,00-8,60	13,60-13,10-12,60	19,10-18,20-17,50	22,70-21,70-20,80
Air flow	Cool / Heat m <sup>3</sup> /min	34,1/36,4	42,0/42,0	42,0/42,0	62,0/66,0	76,0/70,0	86,0/78,0	89,0/83,0
Sound pressure	Cool / Heat (Hi) dB(A)	43/44	46/48	47/50	48/50	52/52	55/55	56/56
Sound power	Cool / Heat (Hi) dB(A)	62/64	64/67	65/69	65/67	69/69	73/73	74/74
Dimension	H x W x D mm	695 x 875 x 320	695 x 875 x 320	695 x 875 x 320	996 x 980 x 370	996 x 980 x 370	996 x 980 x 370	996 x 980 x 370
Net weight	kg	42	42	43	66	84	86	86
Piping diameter	Liquid Inch (mm)	1/4 (6,35)	1/4 (6,35)	1/4 (6,35) <sup>7)</sup>	3/8 (9,52)	3/8 (9,52)	3/8 (9,52)	3/8 (9,52)
	Gas Inch (mm)	1/2 (12,70)	1/2 (12,70)	1/2 (12,70) <sup>8)</sup>	5/8 (15,88)	5/8 (15,88)	5/8 (15,88)	5/8 (15,88)
Pipe length range	m	3-40	3-40	3-40	5-60	5-100	5-100	5-100
Elevation difference (in / out) <sup>9)</sup>	m	15/30	15/30	15/30	15/30	15/30	15/30	15/30
Pre-charged pipe length	m	30	30	30	30	30	30	30
Additional gas amount	g/m	15	15	15	30	40	40	40
Refrigerant (R32) / CO <sub>2</sub> Eq.	kg / T	1,13/0,76	1,13/0,76	1,15/0,78	1,95/1,32	2,70/1,82	3,00/2,03	3,00/2,03
Operating range	Cool Min ~ Max °C	-15 ~ +46	-15 ~ +46	-15 ~ +46	-15 ~ +52	-20 <sup>10)</sup> ~ +52	-20 <sup>10)</sup> ~ +52	-20 <sup>10)</sup> ~ +52
	Heat Min ~ Max °C	-20 ~ +24	-20 ~ +24	-20 ~ +24	-20 ~ +24	-20 ~ +24	-20 ~ +24	-20 ~ +24

## Technical focus

- 2 installation possibilities (horizontal / vertical)
- Maximum external static pressure: 150 Pa
- Selectable inlet air position (rear / bottom entry)
- Improved drain pan suitable for both horizontal / vertical installation
- Drain pump included
- nanoe™ X (Generator Mark 2: 9,6 trillion hydroxyl radicals/sec) as standard for the long duct piping case\*
- BION air pollutant filter for certain types of pollutants, such as nitrogen dioxide (NO<sub>2</sub>), nitrogen oxides (NO<sub>x</sub>) and Ozone (O<sub>3</sub>) (optional)
- Wired remote control CZ-RTC6WBL and CZ-RTC6BL allows easy system setting via Bluetooth®

\*The performance of nanoe™ X air can be expected even by 10 m long duct by Panasonic internal survey.

## 2 installation possibilities (horizontal / vertical)

Vertical installation is available. External static pressure 150 Pa, sufficient for remotely installing units away from the rooms.



## Improved drain pan design

Just one drain pan for both horizontal and vertical installations. No need to modify the unit.

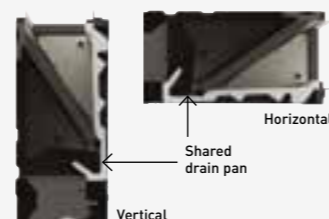

COMPATIBLE WITH ALL PANASONIC CONNECTIVITY SOLUTIONS. FOR DETAILED INFORMATION GO TO THE CONTROL SYSTEMS SECTION

## Optional:

## CONEX

CONEX wired remote controller, white. CZ-RTC6W/BL/BLW2

## CONEX

CONEX wired remote controller, black. CZ-RTC6/BL/BLW2

## Infrared

remote controller. CZ-RWS3 + CZ-RWRC3

## Econavi

sensor. CZ-CENSC1

		Three phase			
		7,1 kW	10,0 kW	12,5 kW	14,0 kW
Kit		KIT-71PF3ZH48	KIT-100PF3ZH48	KIT-125PF3ZH48	KIT-140PF3ZH48
Remote controller		CZ-RTC5B	CZ-RTC5B	CZ-RTC5B	CZ-RTC5B
Cooling capacity	Nominal (Min - Max) kW	6,8(2,2-7,8)	9,5(3,1-11,4)	12,1(3,2-13,6)	13,4(3,3-15,3)
EER <sup>1)</sup>	Nominal (Min - Max) W/W	3,74(2,41-5,64)	4,09(2,82-5,08)	3,53(3,00-5,00)	3,38(2,59-4,18)
<b>SEER / η<sub>sc</sub><sup>2)</sup></b>		<b>7,1 A++</b>	<b>7,4 A++</b>	<b>281,0%</b>	<b>275,2%</b>
P <sub>design</sub>	kW	6,8	9,5	12,1	13,4
Input power	Nominal (Min - Max) kW	1,82(0,39-3,24)	2,32(0,61-4,04)	3,43(0,64-4,54)	3,96(0,79-5,90)
Annual energy consumption <sup>3)</sup>	kWh/a	332	447	—	—
Heating capacity	Nominal (Min - Max) kW	7,5(2,0-9,0)	10,8(3,1-13,5)	13,5(3,2-15,4)	15,5(3,3-17,4)
Heating capacity at -15 °C <sup>4)</sup>	Max kW	7,5	11,5	12,9	14,5
COP <sup>1)</sup>	Nominal (Min - Max) W/W	4,03(3,16-5,41)	3,88(3,07-5,25)	3,46(3,06-5,16)	3,33(3,14-4,29)
<b>SCOP / η<sub>sh</sub><sup>2)</sup></b>		<b>4,7 A++</b>	<b>4,3 A+</b>	<b>165,0%</b>	<b>162,6%</b>
P <sub>design</sub> at -10 °C	kW	4,7	7,8	9,3	9,5
Input power	Nominal (Min - Max) kW	1,86(0,37-2,85)	2,78(0,59-4,40)	3,90(0,62-5,04)	4,65(0,77-5,55)
Annual energy consumption <sup>3)</sup>	kWh/a	1394	2540	—	—
<b>Indoor unit</b>		<b>S-6071PF3E</b>	<b>S-1014PF3E</b>	<b>S-1014PF3E</b>	<b>S-1014PF3E</b>
External static pressure <sup>5)</sup>	Nominal (Min - Max) Pa	30(10-150)	40(10-150)	50(10-150)	50(10-150)
Air flow	Hi / Med / Lo m <sup>3</sup> /min	21,0/19,0/15,0	32,0/26,0/21,0	34,0/29,0/23,0	36,0/32,0/25,0
Moisture removal volume	L/h	2,7	3,2	4,1	4,9
Sound pressure <sup>6)</sup>	Hi / Med / Lo dB(A)	30/26/23	33/29/25	35/31/27	39/35/29
Sound power	Hi / Med / Lo dB(A)	53/49/46	56/52/48	58/54/50	62/58/52
Dimension	H x W x D mm	250 x 1000 x 730	250 x 1400 x 730	250 x 1400 x 730	250 x 1400 x 730
Net weight	kg	30	39	39	39
nanoe X Generator		Mark 2	Mark 2	Mark 2	Mark 2
<b>Outdoor unit</b>		<b>U-71PZH4E8</b>	<b>U-100PZH4E8</b>	<b>U-125PZH4E8</b>	<b>U-140PZH4E8</b>
Power supply	V	380-400-415	380-400-415	380-400-415	380-400-415
Current	Cool A	3,05-2,90-2,80	3,85-3,70-3,50	5,65-5,40-5,20	6,55-6,20-6,00
	Heat A	3,15-3,00-2,90	4,65-4,40-4,20	6,50-6,20-5,95	7,75-7,40-7,05
Air flow	Cool / Heat m <sup>3</sup> /min	62,0/66,0	76,0/70,0	86,0/78,0	89,0/83,0
Sound pressure	Cool / Heat (Hi) dB(A)	48/50	52/52	55/55	56/56
Sound power	Cool / Heat (Hi) dB(A)	65/67	69/69	73/73	74/74
Dimension	H x W x D mm	996 x 980 x 370	996 x 980 x 370	996 x 980 x 370	996 x 980 x 370
Net weight	kg	66	82	84	84
Piping diameter	Liquid Inch (mm)	3/8 (9,52)	3/8 (9,52)	3/8 (9,52)	3/8 (9,52)
	Gas Inch (mm)	5/8 (15,88)	5/8 (15,88)	5/8 (15,88)	5/8 (15,88)
Pipe length range	m	5-60	5-100	5-100	5-100
Elevation difference (in / out) <sup>9)</sup>	m	15/30	15/30	15/30	15/30
Pre-charged pipe length	m	30	30	30	30
Additional gas amount	g/m	30	40	40	40
Refrigerant (R32) / CO <sub>2</sub> Eq.	kg / T	1,95/1,32	2,70/1,82	3,00/2,03	3,00/2,03
Operating range	Cool Min ~ Max °C	-15 ~ +52	-20 <sup>10)</sup> ~ +52	-20 <sup>10)</sup> ~ +52	-20 <sup>10)</sup> ~ +52
	Heat Min ~ Max °C	-20 ~ +24	-20 ~ +24	-20 ~ +24	-20 ~ +24

1) EER and COP calculation is based in accordance to EN 14511. 2) For models below 12 kW, the SEER and SCOP is calculated based on values of EU/26/2011. For models above 12 kW, the η<sub>sc</sub> / η<sub>sh</sub> values is calculated based on EN 14825. 3) Factory setting. 4) The value is based on the interpolation. 5) Medium external static pressure setting from factory. 6) The sound pressure of the units shows the value measured of the position 1,5 m below the unit. The sound pressure is measured in accordance with Eurovent 6/C/006-97 specification. 7) Connect the liquid socket tube (Ø6,35-Ø9,52) to the liquid tubing side indoor unit. 8) Connect the gas socket tube (Ø12,70-Ø15,88) to the gas tubing side indoor unit. 9) Outdoor unit located lower / outdoor unit located higher. 10) Pipe length up to 30 m. \*Recommended fuse for the indoor 3 A. \*\*Above values are in the case of standard installation(horizontal installation in the ceiling, rear side air intake) and nanoe™ X OFF.

## Accessories

<b>CZ-RTC6W</b>	CONEX wired remote controller (non-wireless), white
<b>CZ-RTC6WBL</b>	CONEX wired remote controller with Bluetooth®, white
<b>CZ-RTC6WBLW2</b>	CONEX wired remote controller with Wi-Fi and Bluetooth®, white
<b>CZ-RTC6</b>	CONEX wired remote controller (non-wireless), black
<b>CZ-RTC6BL</b>	CONEX wired remote controller with Bluetooth®, black
<b>CZ-RTC6BLW2</b>	CONEX wired remote controller with Wi-Fi and Bluetooth®, black
<b>CZ-RTC5B</b>	Wired remote controller with Econavi function
<b>CZ-RWS3 + CZ-RWRC3</b>	Infrared remote controller and receiver
<b>CZ-CAPWFC2</b>	Commercial Wi-Fi Adaptor
<b>PAW-PACR4</b>	Interface to run up to 4 indoor unit groups on backup and alternative run

## Accessories

<b>PAW-WTRAY</b>	Tray for condenser water compatible with outdoor elevation platform
<b>PAW-GRDBSE20</b>	Outdoor base ground support for noise and vibration absorption
<b>PAW-GRDSTD40</b>	Outdoor elevation platform 400 x 900 x 400 mm
<b>CZ-CENSC1</b>	Econavi energy saving sensor
<b>CZ-56DAF2</b>	Air outlet plenum for S-3650PF3E
<b>CZ-90DAF2</b>	Air outlet plenum for S-6071PF3E
<b>CZ-160DAF2</b>	Air outlet plenum for S-1014PF3E
<b>PAW-APF800F</b>	BION air pollutant filter for S-3650PF3E
<b>PAW-APF1000F</b>	BION air pollutant filter for S-6071PF3E
<b>PAW-APF1400F</b>	BION air pollutant filter for S-1014PF3E



SEER and SCOP: For S-6071PF3E + U-71PZH4E5. SUPER QUIET: For S-3650PF3E + U-36PZH3E5. INTERNET CONTROL: Optional.

Rating conditions: Cooling indoor 27 °C DB / 19 °C WB. Cooling outdoor 35 °C DB / 24 °C WB. Heating indoor 20 °C DB. Heating outdoor 7 °C DB / 6 °C WB. IDB: Dry Bulb; WB: Wet Bulb. Specifications subject to change without notice. For detailed information about ErP / Energy Lab

**PACi NX Series Standard adaptive ducted unit - PF3 · R32**

**Adaptive ducted unit - PF3.**

2 installation possibilities (horizontal / vertical) with high ESP 150Pa allows flexible installation.



		Single phase							
		3,6 kW	5,0 kW	6,0 kW	7,1 kW	10,0 kW	12,5 kW	14,0 kW	
Kit		KIT-36PF3Z5	KIT-50PF3Z5	KIT-60PF3Z5	KIT-71PF3Z5	KIT-100PF3Z5	KIT-125PF3Z5	KIT-140PF3Z5	
Remote controller		CZ-RTC5B	CZ-RTC5B	CZ-RTC5B	CZ-RTC5B	CZ-RTC5B	CZ-RTC5B	CZ-RTC5B	
Cooling capacity	Nom (Min - Max) kW	3,4(1,5-4,0)	5,0(1,5-5,3)	5,7(2,0-6,3)	6,8(2,6-7,7)	9,5(3,0-11,4)	12,1(3,2-13,5)	13,4(3,3-15,0)	
EER <sup>1)</sup>	Nom (Min - Max) W/W	3,78(3,51-5,00)	2,78(2,76-4,63)	3,54(2,63-5,88)	3,18(2,69-4,56)	3,57(2,36-5,08)	3,40(2,76-5,08)	3,16(2,56-5,08)	
<b>SEER / η<sub>sc</sub> <sup>2)</sup></b>		<b>6,0 A+</b>	<b>6,5 A++</b>	<b>6,4 A++</b>	<b>6,0 A+</b>	<b>6,6 A++</b>	<b>257,4%</b>	<b>252,2%</b>	
Pdesign	kW	3,4	5,0	5,7	6,8	9,5	12,1	13,4	
Input power	Nom (Min - Max) kW	0,90(0,30-1,14)	1,80(0,32-1,92)	1,61(0,34-2,40)	2,14(0,57-2,86)	2,66(0,59-4,84)	3,56(0,63-4,90)	4,24(0,65-5,86)	
Annual energy consumption <sup>3)</sup>	kWh/a	198	267	310	391	502	—	—	
Heating capacity	Nom (Min - Max) kW	3,4(1,5-4,6)	5,0(1,5-5,9)	5,7(1,8-7,0)	6,8(2,1-8,1)	9,5(3,0-13,5)	12,1(3,3-15,0)	13,4(3,4-16,0)	
Heating capacity at -15 °C <sup>4)</sup>	Max kW	2,6	3,5	4,7	4,8	8,0	10,5	10,8	
COP <sup>1)</sup>	Nom (Min - Max) W/W	4,15(3,51-5,36)	3,62(3,06-5,36)	4,04(2,82-6,21)	4,00(3,03-5,68)	4,09(3,00-5,08)	3,56(3,16-5,24)	3,76(3,03-5,23)	
<b>SCOP / η<sub>sh</sub> <sup>2)</sup></b>		<b>4,0 A+</b>	<b>4,0 A+</b>	<b>4,4 A+</b>	<b>4,1 A+</b>	<b>3,9 A</b>	<b>142,6%</b>	<b>140,6%</b>	
Pdesign at -10 °C	kW	2,4	3,8	4,4	4,7	7,8	9,3	9,5	
Input power	Nom (Min - Max) kW	0,82(0,28-1,31)	1,38(0,28-1,73)	1,41(0,29-2,48)	1,70(0,37-2,67)	2,32(0,59-4,50)	3,40(0,63-4,74)	3,56(0,65-5,28)	
Annual energy consumption <sup>3)</sup>	kWh/a	839	1303	1376	1591	2795	—	—	
Indoor unit		S-3650PF3E	S-3650PF3E	S-6071PF3E	S-6071PF3E	S-1014PF3E	S-1014PF3E	S-1014PF3E	
External static pressure <sup>5)</sup>	Nom (Min - Max) Pa	30(10-150)	30(10-150)	30(10-150)	30(10-150)	40(10-150)	50(10-150)	50(10-150)	
Air flow	Hi / Med / Lo m <sup>3</sup> /min	14,0/13,0/10,0	16,0/15,0/12,0	21,0/19,0/15,0	21,0/19,0/15,0	32,0/26,0/21,0	34,0/29,0/23,0	36,0/32,0/25,0	
Moisture removal volume	L/h	0,9	1,9	1,7	2,7	3,2	4,1	4,9	
Sound pressure <sup>6)</sup>	Hi / Med / Lo dB(A)	30/27/22	34/30/25	30/26/23	30/26/23	33/29/25	35/31/27	39/35/29	
Sound power	Hi / Med / Lo dB(A)	53/50/45	57/53/48	53/49/46	53/49/46	56/52/48	58/54/50	62/58/52	
Dimension	H x W x D mm	250 x 800 x 730	250 x 800 x 730	250 x 1000 x 730	250 x 1000 x 730	250 x 1400 x 730	250 x 1400 x 730	250 x 1400 x 730	
Net weight	kg	25	25	30	39	39	39	39	
nanoe X Generator		Mark 2	Mark 2	Mark 2	Mark 2	Mark 2	Mark 2	Mark 2	
Outdoor unit		U-36PZ3E5	U-50PZ3E5	U-60PZ3E5A	U-71PZ3E5A	U-100PZ3E5	U-125PZ3E5	U-140PZ3E5	
Power supply	V	220-230-240	220-230-240	220-230-240	220-230-240	220-230-240	220-230-240	220-230-240	
Current	Cool A	4,15-4,00-3,85	8,35-8,00-7,65	7,45-7,15-6,85	9,95-9,50-9,10	13,30-12,70-12,20	17,20-16,40-15,80	20,50-19,60-18,8	
	Heat A	3,85-3,70-3,50	6,45-6,20-5,95	6,55-6,25-6,00	7,90-7,55-7,25	11,60-11,10-10,60	16,40-15,70-15,00	17,20-16,40-15,80	
Air flow	Cool / Heat m <sup>3</sup> /min	33,6/34,0	32,7/31,9	42,6/41,5	44,7/45,9	73,0/73,0	82,0/80,0	84,0/82,0	
Sound pressure	Cool / Heat (Hi) dB(A)	46/47	46/46	47/48	48/49	52/52	55/55	56/56	
Sound power	Cool / Heat (Hi) dB(A)	64/66	64/64	64/65	66/68	70/70	73/73	74/74	
Dimension	H x W x D mm	619 x 824 x 299	619 x 824 x 299	695 x 875 x 320	695 x 875 x 320	996 x 980 x 370	996 x 980 x 370	996 x 980 x 370	
Net weight	kg	32	35	42	50	83	87	87	
Piping diameter	Liquid Inch (mm)	1/4(Ø6,35)	1/4(Ø6,35)	1/4(Ø6,35) <sup>7)</sup>	1/4(Ø6,35) <sup>7)</sup>	3/8(9,52)	3/8(9,52)	3/8(9,52)	
	Gas Inch (mm)	1/2(Ø12,7)	1/2(Ø12,7)	1/2(Ø12,7) <sup>8)</sup>	5/8(Ø15,88)	5/8(15,88)	5/8(15,88)	5/8(15,88)	
Pipe length range	m	3-15	3-20	3-40	3-40	5-50	5-50	5-50	
Elevation difference (in / out) <sup>9)</sup>	m	15/15	15/15	15/30	20/30	15/30	15/30	15/30	
Pre-charged pipe length	m	7,5	7,5	30	30	30	30	30	
Additional gas amount	g/m	10	15	15	17	45	45	45	
Refrigerant (R32) / CO <sub>2</sub> Eq.	kg / T	0,87/0,59	1,14/0,77	1,15/0,78	1,32/0,89	2,40/1,62	2,80/1,89	2,80/1,89	
Operating range	Cool Min ~ Max °C	-10~+43	-10~+43	-10~+43	-10~+43	-10~+43	-10~+43	-10~+43	
	Heat Min ~ Max °C	-15~+24	-15~+24	-15~+24	-15~+24	-15~+24	-15~+24	-15~+24	

**Technical focus**

- 2 installation possibilities (horizontal / vertical)
- Maximum external static pressure: 150 Pa
- Selectable inlet air position (rear / bottom entry)
- Improved drain pan suitable for both horizontal / vertical installation
- Drain pump included
- nanoe™ X (Generator Mark 2: 9,6 trillion hydroxyl radicals/sec) as standard for the long duct piping case\*
- BION air pollutant filter for certain types of pollutants, such as nitrogen dioxide (NO<sub>2</sub>), nitrogen oxides (NO<sub>x</sub>) and Ozone (O<sub>3</sub>) (optional)
- Wired remote control CZ-RTC6WBL and CZ-RTC6BL allows easy system setting via Bluetooth®

\*The performance of nanoe™ X air can be expected even by 10 m long duct by Panasonic internal survey.

**2 installation possibilities (horizontal / vertical)**

Vertical installation is available. External static pressure 150 Pa, sufficient for remotely installing units away from the rooms.



**Improved drain pan design**

Just one drain pan for both horizontal and vertical installations. No need to modify the unit.

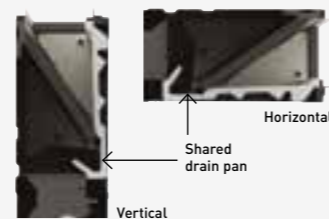

**Optional:**

**CONEX** CONEX wired remote controller, white. CZ-RTC6W/BL/BLW2

**CONEX** CONEX wired remote controller, black. CZ-RTC6/BL/BLW2

Infrared remote controller. CZ-RWS3 + CZ-RWRC3

Econavi sensor. CZ-CENSC1

		Three phase		
		10,0 kW	12,5 kW	14,0 kW
Kit		KIT-100PF3Z8	KIT-125PF3Z8	KIT-140PF3Z8
Remote controller		CZ-RTC5B	CZ-RTC5B	CZ-RTC5B
Cooling capacity	Nominal (Min - Max) kW	9,5(3,0-11,4)	12,1(3,2-13,5)	13,4(3,3-15,0)
EER <sup>1)</sup>	Nominal (Min - Max) W/W	3,57(2,36-5,08)	3,40(2,76-5,08)	3,16(2,56-5,08)
<b>SEER / η<sub>sc</sub> <sup>2)</sup></b>		<b>6,5 A++</b>	<b>256,2%</b>	<b>251,4%</b>
Pdesign	kW	9,5	12,1	13,4
Input power	Nominal (Min - Max) kW	2,66(0,59-4,84)	3,56(0,63-4,90)	4,24(0,65-5,86)
Annual energy consumption <sup>3)</sup>	kWh/a	508	—	—
Heating capacity	Nominal (Min - Max) kW	9,5(3,0-13,5)	12,1(3,3-15,0)	13,4(3,4-16,0)
Heating capacity at -15 °C <sup>4)</sup>	Max kW	8,0	10,5	10,8
COP <sup>1)</sup>	Nominal (Min - Max) W/W	4,09(3,00-5,08)	3,56(3,16-5,24)	3,76(3,03-5,23)
<b>SCOP / η<sub>sh</sub> <sup>2)</sup></b>		<b>3,9 A</b>	<b>142,6%</b>	<b>140,6%</b>
Pdesign at -10 °C	kW	7,8	9,3	9,5
Input power	Nominal (Min - Max) kW	2,32(0,59-4,50)	3,40(0,63-4,74)	3,56(0,65-5,28)
Annual energy consumption <sup>3)</sup>	kWh/a	2795	—	—
Indoor unit		S-1014PF3E	S-1014PF3E	S-1014PF3E
External static pressure <sup>5)</sup>	Nominal (Min - Max) Pa	40(10-150)	50(10-150)	50(10-150)
Air flow	Hi / Med / Lo m <sup>3</sup> /min	32,0/26,0/21,0	34,0/29,0/23,0	36,0/32,0/25,0
Moisture removal volume	L/h	3,2	4,1	4,9
Sound pressure <sup>6)</sup>	Hi / Med / Lo dB(A)	33/29/25	35/31/27	39/35/29
Sound power	Hi / Med / Lo dB(A)	56/52/48	58/54/50	62/58/52
Dimension	H x W x D mm	250 x 1400 x 730	250 x 1400 x 730	250 x 1400 x 730
Net weight	kg	39	39	39
nanoe X Generator		Mark 2	Mark 2	Mark 2
Outdoor unit		U-100PZ3E8	U-125PZ3E8	U-140PZ3E8
Power supply	V	380-400-415	380-400-415	380-400-415
Current	Cool A	4,45-4,20-4,05	5,75-5,45-5,25	6,85-6,50-6,30
	Heat A	3,85-3,70-3,55	5,50-5,20-5,05	5,75-5,45-5,25
Air flow	Cool / Heat m <sup>3</sup> /min	73,0/73,0	82,0/80,0	84,0/82,0
Sound pressure	Cool / Heat (Hi) dB(A)	52/52	55/55	56/56
Sound power	Cool / Heat (Hi) dB(A)	70/70	73/73	74/74
Dimension	H x W x D mm	996 x 980 x 370	996 x 980 x 370	996 x 980 x 370
Net weight	kg	83	87	87
Piping diameter	Liquid Inch (mm)	3/8(9,52)	3/8(9,52)	3/8(9,52)
	Gas Inch (mm)	5/8(15,88)	5/8(15,88)	5/8(15,88)
Pipe length range	m	5-50	5-50	5-50
Elevation difference (in / out) <sup>9)</sup>	m	15/30	15/30	15/30
Pre-charged pipe length	m	30	30	30
Additional gas amount	g/m	45	45	45
Refrigerant (R32) / CO <sub>2</sub> Eq.	kg / T	2,40/1,62	2,80/1,89	2,80/1,89
Operating range	Cool Min ~ Max °C	-10~+43	-10~+43	-10~+43
	Heat Min ~ Max °C	-15~+24	-15~+24	-15~+24

1) EER and COP calculation is based in accordance to EN 14511. 2) For models below 12 kW, the SEER and SCOP is calculated based on values of EU/426/2011. For models above 12 kW, the η<sub>sc</sub> / η<sub>sh</sub> values is calculated based on EN 14825. 3) Factory setting. 4) The value is based on the interpolation. 5) Medium external static pressure setting from factory. 6) The sound pressure of the unit shows the value measured of the position 1,5 m below the unit. The sound pressure is measured in accordance with Eurovent 4/C/006-97 specification. 7) Connect the liquid socket tube (Ø6,35-Ø9,52) to the liquid tubing side indoor unit. 8) Connect the gas socket tube (Ø12,70-Ø15,88) to the gas tubing side indoor unit. 9) Outdoor unit located lower / outdoor unit located higher. \*Recommended fuse for the indoor 3 A. \*\*Above values are in the case of standard installation(horizontal installation in the ceiling, rear side air intake) and nanoe™ X OFF.

Accessories	
<b>CZ-RTC6W</b>	CONEX wired remote controller (non-wireless), white
<b>CZ-RTC6WBL</b>	CONEX wired remote controller with Bluetooth®, white
<b>CZ-RTC6WBLW2</b>	CONEX wired remote controller with Wi-Fi and Bluetooth®, white
<b>CZ-RTC6</b>	CONEX wired remote controller (non-wireless), black
<b>CZ-RTC6BL</b>	CONEX wired remote controller with Bluetooth®, black
<b>CZ-RTC6BLW2</b>	CONEX wired remote controller with Wi-Fi and Bluetooth®, black
<b>CZ-RTC5B</b>	Wired remote controller with Econavi function
<b>CZ-RWS3 + CZ-RWRC3</b>	Infrared remote controller and receiver
<b>CZ-CAPWFC2</b>	Commercial Wi-Fi Adaptor
<b>PAW-PACR4</b>	Interface to run up to 4 indoor unit groups on backup and alternative run

Accessories	
<b>PAW-WTRAY</b>	Tray for condenser water compatible with outdoor elevation platform
<b>PAW-GRDBSE20</b>	Outdoor base ground support for noise and vibration absorption
<b>PAW-GRDSTD40</b>	Outdoor elevation platform 400 x 900 x 400 mm
<b>CZ-CENSC1</b>	Econavi energy saving sensor
<b>CZ-56DAF2</b>	Air outlet plenum for S-3650PF3E
<b>CZ-90DAF2</b>	Air outlet plenum for S-6071PF3E
<b>CZ-160DAF2</b>	Air outlet plenum for S-1014PF3E
<b>PAW-APF800F</b>	BION air pollutant filter for S-3650PF3E
<b>PAW-APF1000F</b>	BION air pollutant filter for S-6071PF3E
<b>PAW-APF1400F</b>	BION air pollutant filter for S-1014PF3E

R32 REFRIGERANT | A++ 6,6 SEER | A+ 4,4 SCOP | INVERTER+ | COOLING MODE -10 °C | HEATING MODE -15 °C | nanoe™ X | 22 dB(A) | DC FAN | FILTER INCLUDED | R32 / R410A REVERSAL | OPTIONAL Wi-Fi | BMS CONNECTIVITY | 5 YEARS COMPRESSOR WARRANTY

SEER: For S-1014PF3E + U-100PZ3E5. SCOP: For S-6071PF3E + U-60PZ3E5A. SUPER QUIET: For S-3650PF3E + U-36PZ3E5. INTERNET CONTROL: Optional.

Rating conditions: Cooling indoor 27 °C DB / 19 °C WB. Cooling outdoor 35 °C DB / 24 °C WB. Heating indoor 20 °C DB. Heating outdoor 7 °C DB / 6 °C WB. IDB: Dry Bulb; WB: Wet Bulb. Specifications subject to change without notice. For detailed information about ErP / Energy Labelling, please visit our websites www.aircon.panasonic.eu or www.ptc.panasonic.eu.

**NEW! PACi NX Series Standard multi zone duct unit - R32**

**Energy efficient ducted unit with individual zone temperature control.**

Simple and efficient zone control installation.



		Single phase				
		7,1 kW	10,0 kW	10,0 kW	12,5 kW	14,0 kW
Kit		KIT-71PQ41Z5	KIT-100PQ41Z5	KIT-100PQ51Z5	KIT-125PQ51Z5	KIT-140PQ51Z5
Remote controller		PCZ-EEB749	PCZ-EEB749	PCZ-EEB749	PCZ-EEB749	PCZ-EEB749
Cooling capacity	Nom (Min - Max) kW	7,0(2,7-7,9)	9,0(3,0-11,0)	9,8(3,1-11,5)	12,0(3,3-13,7)	13,2(3,4-14,8)
SEER / η <sub>sc</sub> <sup>1)</sup>		6,6 A++	6,2 A++	6,6 A++	254,5%	251,8%
Heating capacity	Nom (Min - Max) kW	7,1(2,2-8,2)	9,1(3,0-13,2)	9,7(3,0-11,5)	12,1(3,3-15,2)	13,3(3,5-15,9)
SCOP / η <sub>sh</sub> <sup>1)</sup>		4,3 A+	4,3 A+	4,4 A+	143,2%	141,4%
Indoor unit		S-7110PQ41E	S-7110PQ41E	S-1014PQ51E	S-1014PQ51E	S-1014PQ51E
Number of fans		4	4	5	5	5
External static pressure <sup>2)</sup>	Nom (Min - Max) Pa	30(10-120)	30(10-120)	30(10-130)	30(10-130)	30(10-130)
Air flow	Hi / Med / Lo m <sup>3</sup> /h	1800/1520/1120	1800/1520/1120	2250/1800/1450	2250/1800/1450	2250/1800/1450
Dimension	HxWxD mm	266 x 1164 x 701	266 x 1164 x 701	266 x 1455 x 701	266 x 1455 x 701	266 x 1455 x 701
Net weight	kg	47	47	57	57	57
Outdoor unit		U-71PZ3E5A	U-100PZ3E5	U-100PZ3E5	U-125PZ3E5	U-140PZ3E5
Power supply	V	220-230-240	220-230-240	220-230-240	220-230-240	220-230-240
Current	Cool A	9,95-9,50-9,10	13,30-12,70-12,20	13,30-12,70-12,20	17,20-16,40-15,80	20,50-19,60-18,8
	Heat A	7,90-7,55-7,25	11,60-11,10-10,60	11,60-11,10-10,60	16,40-15,70-15,00	17,20-16,40-15,80
Air flow	Cool / Heat m <sup>3</sup> /min	44,7/45,9	73,0/73,0	73,0/73,0	82,0/80,0	84,0/82,0
Sound pressure	Cool / Heat (Hi) dB(A)	48/49	52/52	52/52	55/55	56/56
Sound power	Cool / Heat (Hi) dB(A)	66/68	70/70	70/70	73/73	74/74
Dimension	HxWxD mm	695 x 875 x 320	996 x 980 x 370	996 x 980 x 370	996 x 980 x 370	996 x 980 x 370
Net weight	kg	50	83	83	87	87
Piping diameter	Liquid Inch (mm)	1/4(Ø6,35) <sup>3)</sup>	3/8(9,52)	3/8(9,52)	3/8(9,52)	3/8(9,52)
	Gas Inch (mm)	5/8(Ø15,88)	5/8(15,88)	5/8(15,88)	5/8(15,88)	5/8(15,88)
Pipe length range	m	3-40	5-50	5-50	5-50	5-50
Elevation difference (in / out) <sup>3)</sup>	m	20/30	15/30	15/30	15/30	15/30
Pre-charged pipe length	m	30	30	30	30	30
Additional gas amount	g/m	17	45	45	45	45
Refrigerant (R32) / CO <sub>2</sub> Eq.	kg / T	1,32/0,89	2,40/1,62	2,40/1,62	2,80/1,89	2,80/1,89
Operating range	Cool Min ~ Max °C	-10 ~ +43	-10 ~ +43	-10 ~ +43	-10 ~ +43	-10 ~ +43
	Heat Min ~ Max °C	-15 ~ +24	-15 ~ +24	-15 ~ +24	-15 ~ +24	-15 ~ +24

**Technical focus**

- Individual zone temperature control with dedicated fans and motors for each outlet integrated
- Multi-zone management for 4 or 5 zones
- Two installation configurations: horizontal or vertical
- Simplified duct installation with reduced system complexity
- No bypass duct required thanks to intelligent direct control, ensuring optimal comfort and efficiency
- Compatible with PACi NX Standard outdoor units

- Drain pump is optional
- Individual zone control via an intuitive wall controller (PCZ-EEB749)
- Smart Wi-Fi control through the Aquarea Home App
- Standard Panasonic controller<sup>1)</sup> used for setup, commissioning, service, and maintenance

1) Controller (CZ-RTC6) must remain connected.

**Multi zone management – Energy saving solution**

Independent temperature control per each zone can be controlled by a wall control.

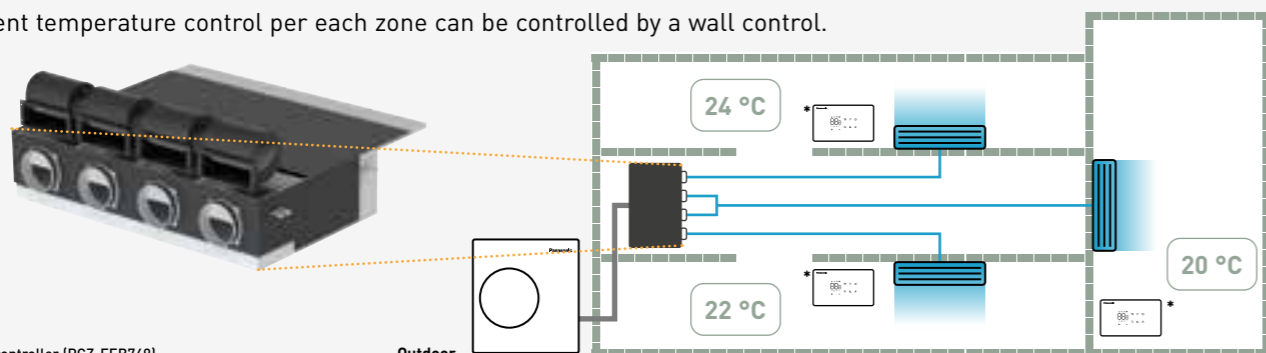

\*Wall-mounted controller (PCZ-EEB749).



		Three phase				
		10,0 kW	10,0 kW	12,5 kW	14,0 kW	
Kit		KIT-100PQ41Z8	KIT-100PQ51Z8	KIT-125PQ51Z8	KIT-140PQ51Z8	
Remote controller		PCZ-EEB749	PCZ-EEB749	PCZ-EEB749	PCZ-EEB749	
Cooling capacity	Nom (Min - Max) kW	9,0(3,0-11,0)	9,8(3,1-11,5)	12,0(3,3-13,7)	13,2(3,4-14,8)	
SEER / η <sub>sc</sub> <sup>1)</sup>		6,2 A++	6,6 A++	253,6%	250,9%	
Heating capacity	Nom (Min - Max) kW	9,1(3,0-13,2)	9,7(3,0-11,5)	12,1(3,3-15,2)	13,3(3,5-15,9)	
SCOP / η <sub>sh</sub> <sup>1)</sup>		4,3 A+	4,4 A+	142,3%	140,6%	
Indoor unit		S-7110PQ41E	S-1014PQ51E	S-1014PQ51E	S-1014PQ51E	
Number of fans		4	5	5	5	
External static pressure <sup>2)</sup>	Nom (Min - Max) Pa	30(10-120)	30(10-130)	30(10-130)	30(10-130)	
Air flow	Hi / Med / Lo m <sup>3</sup> /h	1800/1520/1120	2250/1800/1450	2250/1800/1450	2250/1800/1450	
Dimension	HxWxD mm	266 x 1164 x 701	266 x 1455 x 701	266 x 1455 x 701	266 x 1455 x 701	
Net weight	kg	47	57	57	57	
Outdoor unit		U-100PZ3E8	U-100PZ3E8	U-125PZ3E8	U-140PZ3E8	
Power supply	V	380-400-415	380-400-415	380-400-415	380-400-415	
Current	Cool A	4,45-4,20-4,05	4,45-4,20-4,05	5,75-5,45-5,25	6,85-6,50-6,30	
	Heat A	3,85-3,70-3,55	3,85-3,70-3,55	5,50-5,20-5,05	5,75-5,45-5,25	
Air flow	Cool / Heat m <sup>3</sup> /min	73,0/73,0	73,0/73,0	82,0/80,0	84,0/82,0	
Sound pressure	Cool / Heat (Hi) dB(A)	52/52	52/52	55/55	56/56	
Sound power	Cool / Heat (Hi) dB(A)	70/70	70/70	73/73	74/74	
Dimension	HxWxD mm	996 x 980 x 370	996 x 980 x 370	996 x 980 x 370	996 x 980 x 370	
Net weight	kg	83	83	87	87	
Piping diameter	Liquid Inch (mm)	3/8(9,52)	3/8(9,52)	3/8(9,52)	3/8(9,52)	
	Gas Inch (mm)	5/8(15,88)	5/8(15,88)	5/8(15,88)	5/8(15,88)	
Pipe length range	m	5-50	5-50	5-50	5-50	
Elevation difference (in / out) <sup>3)</sup>	m	15/30	15/30	15/30	15/30	
Pre-charged pipe length	m	30	30	30	30	
Additional gas amount	g/m	45	45	45	45	
Refrigerant (R32) / CO <sub>2</sub> Eq.	kg / T	2,40/1,62	2,40/1,62	2,80/1,89	2,80/1,89	
Operating range	Cool Min ~ Max °C	-10 ~ +43	-10 ~ +43	-10 ~ +43	-10 ~ +43	
	Heat Min ~ Max °C	-15 ~ +24	-15 ~ +24	-15 ~ +24	-15 ~ +24	

1) For models below 12 kW, the SEER and SCOP is calculated based on values of EU/626/2011. For models above 12 kW, the η<sub>sc</sub> / η<sub>sh</sub> values is calculated based on EN 14825. 2) Medium external static pressure setting from factory. 3) Outdoor unit located lower / outdoor unit located higher. \*Recommended fuse for the indoor 3 A.

**Accessories**

<b>PCZ-EEB749</b>	Wall-mounted control
<b>PCZ-AHRD0468</b>	Return plenum with 4 circular inlets DN 160 mm. For S-7110PQ41E
<b>PCZ-AHRD0469</b>	Return plenum with 5 circular inlets DN 160 mm. For S-1014PQ51E
<b>PCZ-AHRD0519</b>	Non-return damper
<b>PCZ-AHRD0524</b>	90° shooting plenum. For S-7110PQ41E
<b>PCZ-AHRD0525</b>	90° shooting plenum. For S-1014PQ51E
<b>PCZ-AHRD0534</b>	Telescopic kit for rear or directly coupled suction. 153 mm - 270 mm. For S-7110PQ41E
<b>PCZ-AHRD0535</b>	Telescopic kit for rear or directly coupled suction. 153 mm - 270 mm. For S-1014PQ51E
<b>PCZ-AHRD0544</b>	Grille for telescopic kit for rear intake. For S-7110PQ41E
<b>PCZ-AHRD0545</b>	Grille for telescopic kit for rear intake. For S-1014PQ51E
<b>PCZ-AHRA0708</b>	Insulated plenum for horizontal or vertical supply/return. For S-7110PQ41E
<b>PCZ-AHRA0709</b>	White aluminium supply grille with double row of adjustable fins (450 x 225 mm). For S-7110PQ41E
<b>PCZ-AHRA0710</b>	White aluminium intake grille with removable filter (450 x 225 mm). For S-7110PQ41E

**Accessories**

<b>PCZ-AHRD0494</b>	Replacement recirculation filter kit. For S-7110PQ41E
<b>PCZ-AHRD0495</b>	Replacement recirculation filter kit. For S-1014PQ51E
<b>PCZ-AHRD0642</b>	Plenum kit for external air connection with damper for room recirculation. For S-7110PQ41E
<b>PCZ-AHRD0643</b>	Plenum kit for external air connection with damper for room recirculation. For S-1014PQ51E
<b>PCZ-AHRD0654</b>	Ducting plate plenum kit for outdoor air connection with damper. For S-7110PQ41E
<b>PCZ-AHRD0655</b>	Ducting plate plenum kit for outdoor air connection with damper. For S-1014PQ51E
<b>PCZ-AHRD0659</b>	90° plenum for outdoor air kit with damper. For S-7110PQ41E
<b>PCZ-AHRD0660</b>	90° plenum for outdoor air kit with damper. For S-1014PQ51E
<b>PCZ-AHRD0664</b>	Telescopic kit. For plenum for outdoor air kit with damper. For S-7110PQ41E
<b>PCZ-AHRD0665</b>	Telescopic kit. For plenum for outdoor air kit with damper. For S-1014PQ51E
<b>PCZ-AHRD0669</b>	Grille for telescopic kit. For plenum for outdoor air kit with damper. For S-7110PQ41E
<b>PCZ-AHRD0670</b>	Grille for telescopic kit. For plenum for outdoor air kit with damper. For S-1014PQ51E



SEER and SCOP: For S-1014PQ51E + U-100PZ3E5 and S-1014PQ51E + U-100PZ3E8. INTERNET CONTROL: Optional.

Rating conditions: Cooling indoor 27 °C DB / 19 °C WB. Cooling outdoor 35 °C DB / 24 °C WB. Heating indoor 20 °C DB. Heating outdoor 7 °C DB / 6 °C WB. (DB: Dry Bulb; WB: Wet Bulb). Specifications subject to change without notice. For detailed information about ErP / Energy Labelling, please visit our websites www.aircon.panasonic.eu or www.ptc.panasonic.eu.

**Big PACi NX Elite high static pressure hide-away**  
20,0-25,0 kW · R32

nanoe™ X (Generator Mark 3).  
Maximum piping length 100 m.  
High external static pressure, maximum 200 Pa setting.



		Three phase	
		20,0 kW	25,0 kW
<b>Kit</b>		<b>KIT-200PE4ZH8</b>	<b>KIT-250PE4ZH8</b>
<b>Remote controller</b>		<b>CZ-RTC5B</b>	<b>CZ-RTC5B</b>
Cooling capacity	Nominal (Min - Max)	kW 19,0 (5,7 - 20,0)	22,0 (6,1 - 25,6)
EER <sup>1)</sup>	Nominal (Min - Max)	W/W 3,20 (2,78 - 4,60)	2,74 (2,49 - 4,88)
$\eta_{s,c}$ <sup>2)</sup>		<b>237,8%</b>	<b>213,0%</b>
Pdesign	kW	19,0	22,0
Input power	Nominal (Min - Max)	kW 5,93 (1,24 - 7,20)	8,04 (1,25 - 10,30)
Heating capacity	Nominal (Min - Max)	kW 22,4 (5,0 - 24,5)	24,0 (5,5 - 27,6)
Heating capacity at -15 °C <sup>3)</sup>	Max	kW 16,8	19,0
COP <sup>1)</sup>	Nominal (Min - Max)	W/W 3,55 (3,27 - 4,76)	3,55 (3,07 - 4,78)
$\eta_{s,h}$ <sup>2)</sup>		<b>151,1%</b>	<b>150,2%</b>
Pdesign at -10 °C	kW	14,50	15,00
Input power	Nominal (Min - Max)	kW 6,31 (1,05 - 7,50)	6,76 (1,15 - 9,00)
<b>Indoor unit</b>		<b>S-200PE4E</b>	<b>S-250PE4E</b>
External static pressure at shipment (adjustable)	Pa	75 <sup>4)</sup> (120 / 180)	75 <sup>4)</sup> (130 / 200)
Air flow	Hi / Med / Lo	m <sup>3</sup> /min 72 / 63 / 53	84 / 72 / 59
Sound pressure <sup>5)</sup>	Hi / Med / Lo	dB(A) 46 / 44 / 41	47 / 45 / 42
Dimension / Net weight	HxWxD	mm / kg 486 x 1456 x 916 / 83	486 x 1456 x 916 / 87
nanoe X Generator		Mark 3	Mark 3
<b>Outdoor unit</b>		<b>U-200PZH4E8</b>	<b>U-250PZH4E8</b>
Power supply	V / ph / Hz	380 - 400 - 415 / 3 / 50	380 - 400 - 415 / 3 / 50
Recommended fuse	A	30	30
Air flow	Cool / Heat	m <sup>3</sup> /min 116 / 136	116 / 148
Sound pressure	Cool / Heat (Hi)	dB(A) 57 / 61	57 / 63
Sound power	Cool / Heat (Hi)	dB(A) 76 / 80	76 / 82
Dimension <sup>6)</sup> / Net weight	HxWxD	mm / kg 996 x 1140 x 460 / 109	996 x 1140 x 460 / 109
Piping diameter	Liquid / Gas	Inch (mm) 1/2 (12,7) / 7/8 (22,22)	1/2 (12,7) / 7/8 (22,22)
Pipe length range / Elevation difference (in / out)	m / m	5 - 100 / 30	5 - 100 / 30
Pre-charged pipe length / Additional gas amount	m / g/m	30 / 80	30 / 80
Refrigerant (R32) / CO <sub>2</sub> Eq.	kg / T	4,8 / 3,24	4,8 / 3,24
Operating range	Cool Min ~ Max	°C -15 ~ +52	-15 ~ +52
	Heat Min ~ Max	°C -20 ~ +35	-20 ~ +35

1) EER and COP calculation is based in accordance to EN 14511. 2) Energy Label Scale from A+++ to D. For models above 12 kW, the  $\eta_{s,c}$  /  $\eta_{s,h}$  values is calculated based on EN 14825. 3) The value is based on the interpolation. 4) Factory setting. 5) The sound pressure of the units shows the value measured of the position 1,5 m below the unit. The sound pressure is measured in accordance with Eurovent 6/C/006-97 specification. 6) Add 100 mm for indoor unit or 70 mm for outdoor unit for piping port.

Accessories	
<b>CZ-RTC6W</b>	CONEX wired remote controller (non-wireless), white
<b>CZ-RTC6WBL</b>	CONEX wired remote controller with Bluetooth®, white
<b>CZ-RTC6WBLW2</b>	CONEX wired remote controller with Wi-Fi and Bluetooth®, white
<b>CZ-RTC6</b>	CONEX wired remote controller (non-wireless), black
<b>CZ-RTC6BL</b>	CONEX wired remote controller with Bluetooth®, black
<b>CZ-RTC6BLW2</b>	CONEX wired remote controller with Wi-Fi and Bluetooth®, black
<b>CZ-RTC5B</b>	Wired remote controller with Econavi function

Accessories	
<b>CZ-RWS3 + CZ-RWRC3</b>	Infrared remote controller and receiver
<b>CZ-CAPWFC2</b>	Commercial Wi-Fi Adaptor
<b>PAW-PACR4</b>	Interface to run up to 4 indoor unit groups on backup and alternative run
<b>PAW-GRDSTD1100</b>	Outdoor ground stand
<b>PAW-GRDBSE20</b>	Outdoor base ground support for noise and vibration absorption
<b>CZ-CENSC1</b>	Econavi energy saving sensor

**Demand response compliant as a standard function**

Several setting levels are available:

- Level-1, 2, 3: 75 / 50 / 0%
  - Level-1, 2 can be set in 40 - 100% (40, 45, 50...95, 100: each 5%)
- It allows for forced stop which can be used for fire-alarm connection on LV3.

\*PAW-OPT-NX is required.

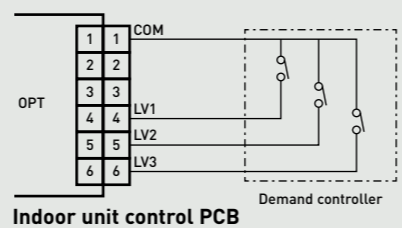

COMPATIBLE WITH ALL PANASONIC CONNECTIVITY SOLUTIONS. FOR DETAILED INFORMATION GO TO THE CONTROL SYSTEMS SECTION



INTERNET CONTROL: Optional.

**PACi NX Jet Air Stream - R32**

Energy saving solution for year-round heating and cooling in large and high spaces.  
High air volume up to 5000 m<sup>3</sup>/h and long maximum air throw distance of 30 m.  
Optimal comfort with Smart Jet - self-directing nozzles.  
Versatile controller options available including Wi-Fi control.



		2500 m <sup>3</sup> /h		2500 m <sup>3</sup> /h		5000 m <sup>3</sup> /h	
		KIT-140MC5AZH5		KIT-140MC5AZH8		KIT-250MC5AZH8	
		CZ-RTC5B		CZ-RTC5B		CZ-RTC5B	
Cooling capacity	Nominal (Min - Max)	kW 14,1 (3,3 - 18,0)	14,1 (3,3 - 18,0)	24,2 (6,1 - 25,6)			
EER <sup>1)</sup>	Nominal (Min - Max)	W/W 3,46 (2,74 - 5,32)	3,46 (2,74 - 5,32)	3,80 (2,49 - 4,88)			
$\eta_{s,c}$ <sup>2)</sup>		<b>227%</b>	<b>227%</b>	<b>250%</b>			
Pdesign	kW	—	—	—			
Heating capacity	Nominal (Min - Max)	kW 14,0 (3,3 - 18,0)	14,0 (3,3 - 18,0)	26,7 (5,5 - 27,6)			
COP <sup>1)</sup>	Nominal (Min - Max)	W/W 3,88 (3,27 - 5,50)	3,88 (3,27 - 5,50)	3,74 (3,07 - 4,78)			
$\eta_{s,h}$ <sup>2)</sup>		<b>155%</b>	<b>155%</b>	<b>155%</b>			
Pdesign at -10 °C	kW	11,0	11,0	18,5			
<b>Indoor unit</b>		<b>Jet Air Stream Smart</b>	<b>Jet Air Stream Smart</b>	<b>Jet Air Stream Smart</b>			
		<b>P-VTVF140MC5A-PE</b>	<b>P-VTVF140MC5A-PE</b>	<b>P-VTVF250MC5A-PE</b>			
Nozzles type		Smart Jet - self-directing nozzles	Smart Jet - self-directing nozzles	Smart Jet - self-directing nozzles			
Number of nozzles		2	2	4			
External static pressure	Pa	170	170	170			
Air flow	m <sup>3</sup> /h	2560	2560	5010			
Sound pressure <sup>3)</sup>	Cool / Heat	dB(A) 42	42	46			
Sound power <sup>4)</sup>	Hi / Med / Lo	dB(A) —	—	—			
Dimension <sup>5)</sup> (HxWxD)	mm	808 x 1106 x 877	808 x 1106 x 877	1041 x 1458 x 930			
Net weight	kg	93	93	140			
<b>Outdoor unit</b>		<b>U-140PZH4E5</b>	<b>U-140PZH4E8</b>	<b>U-250PZH4E8</b>			
Power supply	V / ph / Hz	220 - 230 - 240 / 1 / 50	380 - 400 - 415 / 3 / 50	380 - 400 - 415 / 3 / 50			
Recommended fuse	A	40	16	30			
Sound pressure	Cool / Heat (Hi)	dB(A) 56 / 56	56 / 56	59 / 63			
Dimension / Net weight	HxWxD	mm / kg 996 x 980 x 370 / 86	996 x 980 x 370 / 84	996 x 1140 x 460 / 109			
Piping diameter	Liquid	Inch (mm) 3/8 (9,52)	3/8 (9,52)	1/2 (12,70)			
	Gas	Inch (mm) 5/8 (15,88)	5/8 (15,88)	7/8 (22,22)			
Pipe length range	m	5 - 100	5 - 100	5 - 100			
Elevation difference (in / out)	m	15 / 30 <sup>5)</sup>	15 / 30 <sup>5)</sup>	30			
Pre-charged pipe length	m	30	30	30			
Additional gas amount	g/m	40	40	80			
Refrigerant (R32) / CO <sub>2</sub> Eq.	kg / T	3,00 / 2,03	3,00 / 2,03	4,80 / 3,24			
Operating range	Cool Min ~ Max	°C -20 <sup>6)</sup> ~ +52	-20 <sup>6)</sup> ~ +52	-15 ~ +52			
	Heat Min ~ Max	°C -20 ~ +24	-20 ~ +24	-20 ~ +35			

1) EER and COP calculation is based in accordance to EN 14511. 2) For models above 12 kW, the  $\eta_{s,c}$  /  $\eta_{s,h}$  values is calculated based on EN 14825. 3) Average sound pressure at 5 m Lp. 4) Radiated sound power at 5 m Lp. 5) Outdoor unit located lower / outdoor unit located higher. 6) Pipe length up to 30 m. 7) Nozzles and Ducts thickness included.

Optional configurations*	Front panel type	Air flow (m <sup>3</sup> /h)	Dimension / Net weight	
<b>P-VTVF140NC5A-PE</b>	Jet Air Stream Standard	Manual nozzles	2500	808 x 1106 x 877 / 93
<b>P-VTVF250NC5A-PE</b>	Jet Air Stream Standard	Manual nozzles	5000	1041 x 1458 x 930 / 140
<b>P-VTVF140PC5A-PE</b>	Jet Air Stream Ducted	Ducted front panel	2500	808 x 1106 x 910 / 93
<b>P-VTVF250PC5A-PE</b>	Jet Air Stream Ducted	Ducted front panel	5000	1041 x 1458 x 963 / 140

\*The product technical data is the same as Jet Air Stream Smart.

Accessories	
<b>CZ-RTC6W</b>	CONEX wired remote controller (non-wireless), white
<b>CZ-RTC6WBL</b>	CONEX wired remote controller with Bluetooth®, white
<b>CZ-RTC6WBLW2</b>	CONEX wired remote controller with Wi-Fi and Bluetooth®, white
<b>CZ-RTC6</b>	CONEX wired remote controller (non-wireless), black
<b>CZ-RTC6BL</b>	CONEX wired remote controller with Bluetooth®, black
<b>CZ-RTC6BLW2</b>	CONEX wired remote controller with Wi-Fi and Bluetooth®, black
<b>CZ-RTC5B</b>	Wired remote controller with Econavi function
<b>CZ-RWS3 + CZ-RWRC3</b>	Infrared remote controller and receiver
<b>CZ-CAPWFC2</b>	Commercial Wi-Fi Adaptor

Accessories	
<b>PCZ-AHRX0056</b>	Ducted air intake plenum (1 x DN 355 mm) for VTVF140
<b>PCZ-AHRX0057</b>	Ducted air intake plenum (2 x DN 355 mm) for VTVF250
<b>PCZ-AHRX0061</b>	Ground air intake module (VTVF250 requires two of them)
<b>PCZ-AHRX0071</b>	Air supply grille for ducts

**Accessories for remote air intake configurations.**

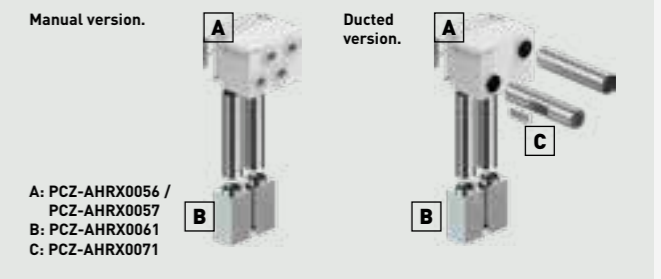

A: PCZ-AHRX0056 / PCZ-AHRX0057  
B: PCZ-AHRX0061  
C: PCZ-AHRX0071



# PACi NX with Water Heat Exchanger for chilled and hot water production

A highly-efficient Water Heat Exchanger for PACi NX Series.  
This ground-breaking product provides further possibilities by adding hydronic options.

Water outlet temperature:  
Cooling: 5 ~ 15 °C  
Heating: 30 ~ 55 °C



## Highly-efficient Water Heat Exchanger for PACi NX Series.

System example.

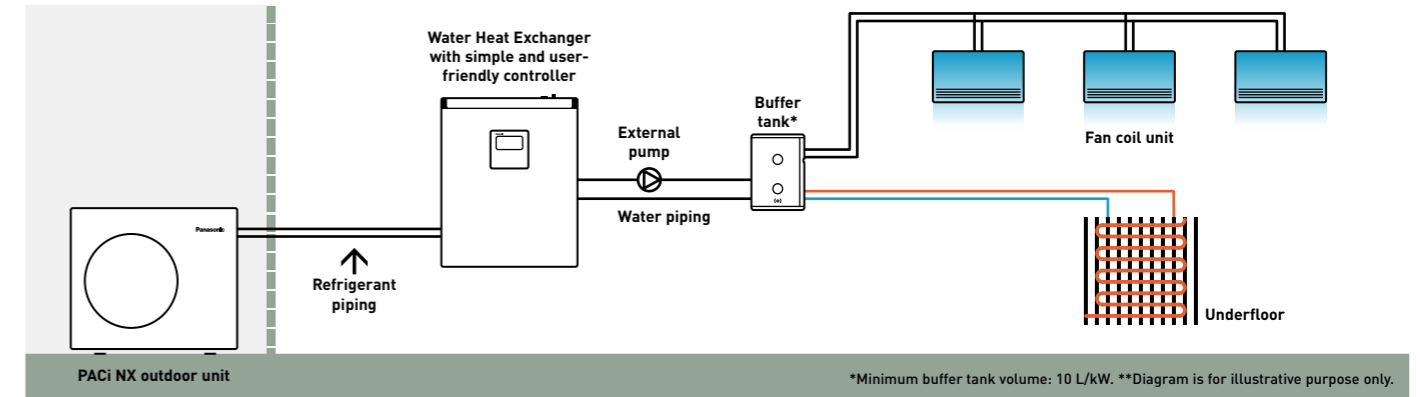

- 1 Cost saving solution**
  - A+++ Energy efficiency class (scale from A+++ to D)
  - Cost effective water projects thanks to lower cost for PACi NX compared to VRF
  - Reducing the amount of HFC refrigeration in the project
- 2 Flexible and space saving system**
  - 2 installation possibilities (wall-mounted / floor-standing)
  - Compact, lightweight unit design, only 27 kg
- 3 Easy installation, maintenance**
  - Quick mounting process
  - Flow switch kit is included as a standard
  - Direct access to electrical box
  - Operation down to -20 °C ambient without the need for glycol

### Flexible and space saving system

- Compact and light unit.**
- Only 205 mm depth fits within a limited space
  - Lightweight design at only 27 kg, makes it easy to maneuver and position
  - Maximum total refrigerant piping length: 100 m

### 2 installation options.

- Wall-mounted and floor-standing installation options are available. Free-up floor space by using the wall-mounted installation
- Quick mounting process with its lightweight compact design  
Make fixing holes > Fix 2 screws > Hang the unit > Finish

- Only 205 mm depth
- Light weight 27 kg
- Piping length 90 m



Quick simple Install



Installer friendly

Wall-mounted.

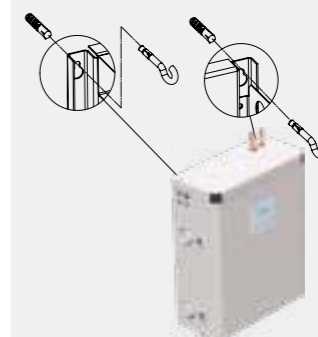

Floor-standing.



\*Support feet included.

### Foodchain/Small office application

- Fulfilling R32 refrigerant needs to follow environmental perspective, Company policy
- Hydraulic system to reduce total amount of HFC refrigeration
- Water solution to substitute electric heating system



Foodchain.

### Residential/Commercial retail application

- Water solution to substitute existing boiler system
- For heating projects with longer than 50 m piping



Commercial retail.

**PACi NX Water Heat Exchanger (WHE) is the ideal solution for residential and commercial applications; the investment costs can be amortised in a short period.**

**Easy maintenance operation from two points of access**

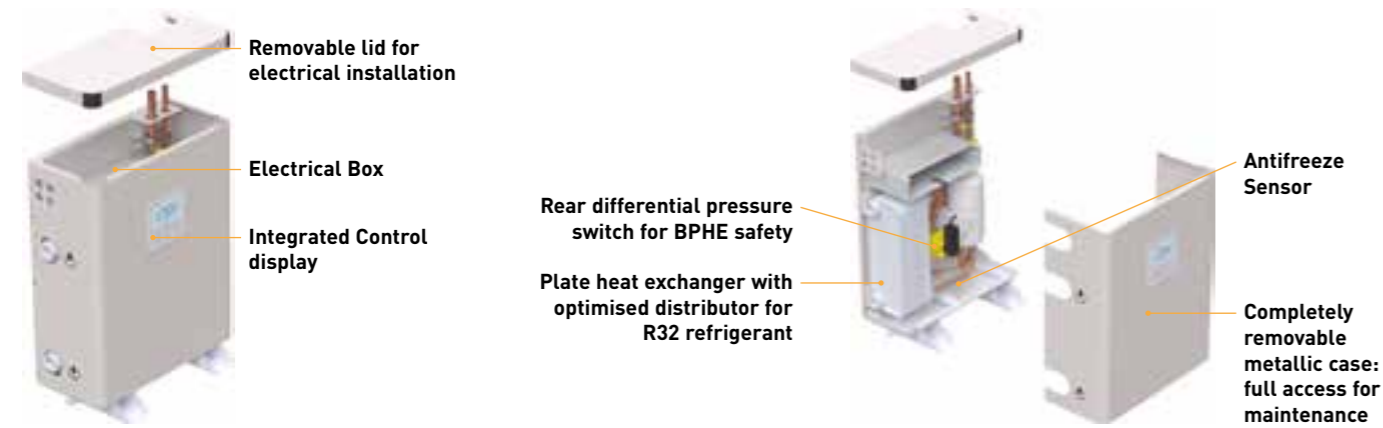

**Integrated cascade control as standard for maximum ease and flexibility**

**Built-in cascade control for 2 units.**

The control of 2 refrigerant systems can be combined together in a cascade. This option is included in the standard scope of delivery on the WHE. It is activated using the one of the CZ-RTC5B remote controllers on the units as master. Rotation and Backup operation modes can be selected.

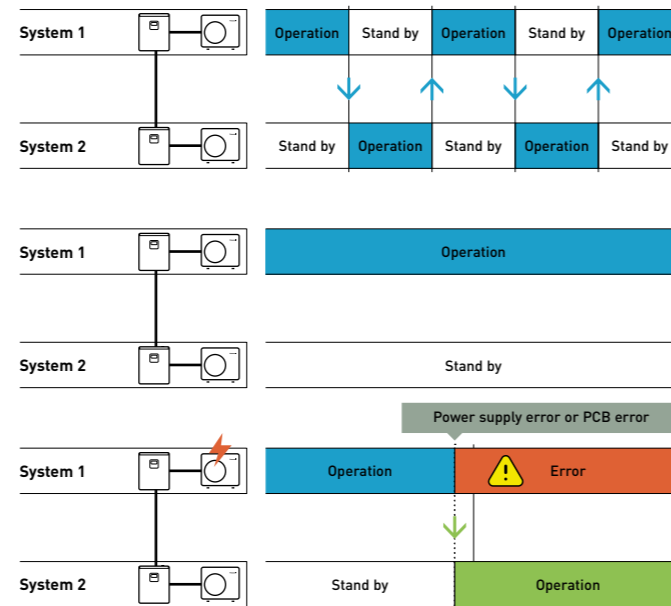
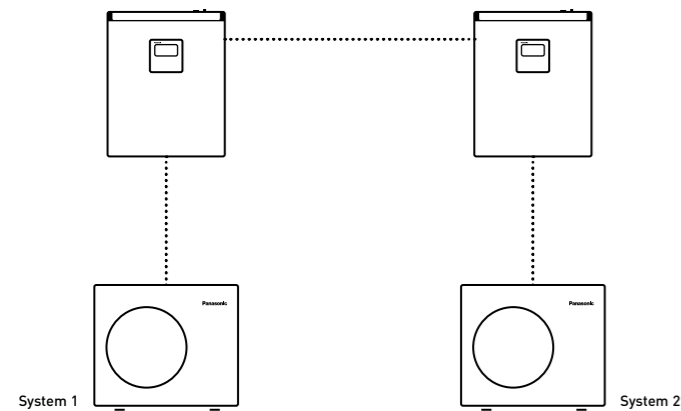

\*One of built-in controllers should be deactivated.

**PACi NX Water Heat Exchanger can be connected as a cascade with up to 4 groups of 8 units, reaching up to 800 kW**

Optional PAW-PACR4 cascade controller allows up to four groups, with each group containing between 1-8 units, to be combined into a cascade for failure substitution or temperature assist.

- Maximum 4 groups (up to 8 units per group)
- Rotation
- Failure substitution
- Temperature assist
- Operation output signal
- Alarm output signal

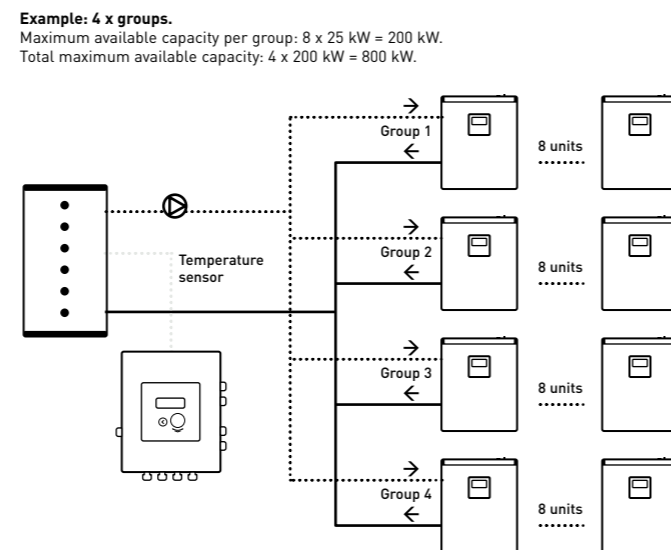

**PACi NX with Water Heat Exchanger for chilled and hot water production**

Hydronic solution with PACi NX for a quick return on investment. Constant 55 °C flow available.



**Short-term investment recovery.**

PACi NX Water Heat Exchanger is ideal for small offices and retails. The investment costs can be amortised within a very short period. This solution allows investors and operators to save money.

Model		PAW-200W5APAC-2	PAW-250W5APAC-2
Cooling capacity <sup>1)</sup>	kW	17,92	22,98
EER <sup>1)</sup>	W/W	2,95	2,65
Heating capacity <sup>2)</sup>	kW	23,06	26,00
COP <sup>2)</sup>	W/W	3,69	3,47
Energy efficiency class (Scale A+++ to D) <sup>3)</sup>	35 °C (low temperature HP)	A+++	A+++
	55 °C (low temperature HP)	A++	A+
η <sub>h,h</sub> (LOT1) <sup>4)</sup>		179,8%	176,5%
Dimension	H x W x D mm	550 x 455 x 205	550 x 455 x 205
Net weight	kg	27	27
Water pipe connector	Inch	Male Thread 1 1/4	Male Thread 1 1/4
Cooling water flow (ΔT=5 K, 35 °C)	m <sup>3</sup> /h	3,45	4,30
Heating water flow (ΔT=5 K, 35 °C)	m <sup>3</sup> /h	4,15	4,85
Flow switch		Included	Included
Water filter		Included	Included
<b>Outdoor unit</b>		<b>U-200PZH4E8</b>	<b>U-250PZH4E8</b>
Sound pressure	Cool / Heat (Hi) dB(A)	57 / 61	57 / 63
Dimension <sup>5)</sup>	H x W x D mm	996 x 1140 x 460	996 x 1140 x 460
Net weight	kg	109	109
Piping diameter	Liquid	Inch (mm)	1/2 (12,70)
	Gas	Inch (mm)	7/8 (22,20)
Pipe length range	m	5 - 100	5 - 100
Elevation difference (in / out)	m	30	30
Pre-charged pipe length	m	30	30
Additional gas amount	g/m	80	80
Water outlet temperature range	Cool Min - Max °C	+5 - +15	+5 - +15
	Heat Min - Max °C	+30 - +55	+30 - +55
Operating range	Cool Min - Max °C	-15 - +52	-15 - +52
	Heat Min - Max °C	-20 - +35	-20 - +35

1) Data refers to 7 °C leaving chilled water temperature and 35 °C ambient air temperature, according to EN 14511 standard. 2) Data refers to 35 °C leaving warm water temperature and 7 °C ambient air temperature according to EN 14511 standard. 3) Following COMMISSION REGULATION (EU) No 811/2013 for low-temperature heat pumps. Scale from A+++ to D. 4) Following COMMISSION REGULATION (EU) No 813/2013 for low-temperature heat pumps. 5) Add 100 mm for indoor unit or 70 mm for outdoor unit for piping port.

**Professional solution**

Many air conditioning manufacturers are selling R32 systems and it is becoming the standard refrigerant for split type air conditioning, because R32 has a much lower global warming potential than R410A, and can also provide higher efficiency.

**Quick installation with pre-assembled flow switch**

The flow switches come pre-assembled with pipe fittings for ease of installation. Operation down to -20 °C with no glycol as the heat exchanger is installed indoors.

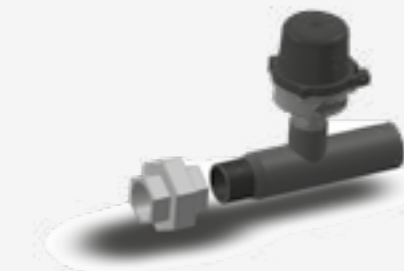

## Commercial twin, triple and double-twin systems



With this system, a single outdoor unit can split its capacity simultaneously across up to 4 indoor units, for better distribution within the space. This makes the system particularly apt for common areas. It reduces noise concentration and enables the same temperature to be reached around the room. A wide variety of the same type of indoor units can be connected in multi combinations (including wall-mounted, cassette, hide-away and ceiling).

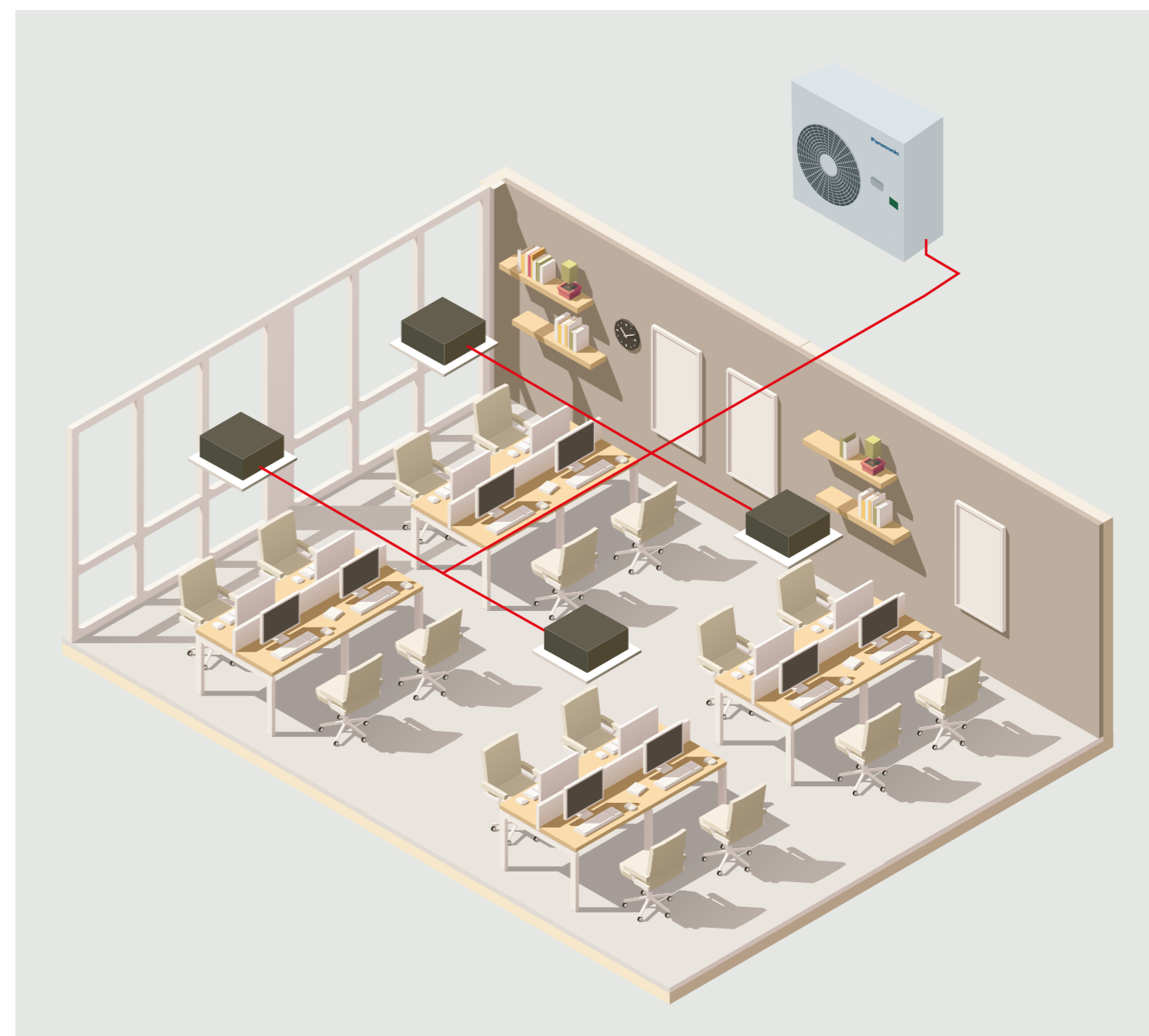

### 1 PACi NX Elite from 5,0 to 14,0 kW

Up to 4 indoor units can be connected to the same outdoor unit. Panasonic's Elite units 5,0, 7,1, 10,0, 12,0 and 14,0 can be installed as twin, triple and double-twin systems. The indoor units can be combined as per the selection table. The operation will always be simultaneous. All the indoor units will work with the same settings.

### 2 Big PACi NX Elite from 20,0 to 25,0 kW

Up to 4 indoor units can be connected to the same outdoor unit. Panasonic's PACi NX units 20,0 and 25,0 can be installed as twin, triple and double-twin systems. The indoor units can be combined as per the selection table. The operation will always be simultaneous. All the indoor units will work with the same settings.

### 3 PACi NX Standard from 10,0 to 14,0 kW

Up to 2 indoor units connectable on the same outdoor. Panasonic's Standard units can be installed as single and twin systems. The indoor units can be combined following the selection table. The operation will always be simultaneous. All the indoor units will work with the same settings.

# Commercial twin, triple and double-twin systems



## PACi NX Elite outdoor units - R32

		PACi NX				Big PACi NX		
		5,0 kW	7,1 kW	10,0 kW	12,5 kW	14,0 kW	20,0 kW	25,0 kW
<b>Outdoor unit single phase</b>		<b>U-50PZH3E5</b>	<b>U-71PZH4E5</b>	<b>U-100PZH4E5</b>	<b>U-125PZH4E5</b>	<b>U-140PZH4E5</b>	—	—
<b>Outdoor unit three phase</b>		—	<b>U-71PZH4E8</b>	<b>U-100PZH4E8</b>	<b>U-125PZH4E8</b>	<b>U-140PZH4E8</b>	<b>U-200PZH4E8</b>	<b>U-250PZH4E8</b>
Cooling capacity <sup>1)</sup>	Nominal (Min - Max) kW	5,0(1,2 - 5,6)	7,1(2,2 - 9,0)	9,5(3,1 - 12,5)	12,5(3,2 - 14,0)	13,4(3,3 - 16,0)	19,0(5,7 - 20,0)	22,0(6,1 - 25,6)
Heating capacity <sup>1)</sup>	Nominal (Min - Max) kW	5,6(1,2 - 6,5)	8,0(2,0 - 9,0)	11,2(3,1 - 14,0)	14,0(3,2 - 16,0)	16,0(3,3 - 18,0)	22,4(5,0 - 24,5)	24,0(5,5 - 27,6)
Power supply	Single phase V	220 - 230 - 240	220 - 230 - 240	220 - 230 - 240	220 - 230 - 240	220 - 230 - 240	—	—
	Three phase V	—	380 - 400 - 415	380 - 400 - 415	380 - 400 - 415	380 - 400 - 415	380 - 400 - 415	380 - 400 - 415
Connection indoor / outdoor	mm <sup>2</sup>	2x1,5 or 2,5	2x1,5 or 2,5	2x1,5 or 2,5	2x1,5 or 2,5	2x1,5 or 2,5	—	—
Air flow	Cool / Heat m <sup>3</sup> /min	42,0/42,0	62,0/66,0	76,0/70,0	86,0/78,0	89,0/83,0	164/164	160/160
Sound pressure	Cool / Heat (Hi) dB(A)	46/48	48/50	52/52	55/55	56/56	59/61	59/63
Sound power	Cool / Heat (Hi) dB(A)	64/67	65/67	69/69	73/73	74/74	77/79	78/82
Dimension	H x W x D mm	695 x 875 x 320	996 x 980 x 370	996 x 980 x 370	996 x 980 x 370	996 x 980 x 370	996 x 1140 x 460	996 x 1140 x 460
Net weight	1ph / 3ph kg	42	66	84/82	86/84	86/84	109	109
	Liquid Inch (mm)	1/4(6,35)	3/8(9,52)	3/8(9,52)	3/8(9,52)	3/8(9,52)	1/2(12,70)	1/2(12,70)
Piping diameter	Gas Inch (mm)	1/2(12,70)	5/8(15,88)	5/8(15,88)	5/8(15,88)	5/8(15,88)	7/8(22,22)	7/8(22,22)
	Min - Max m	3 - 40	5 - 60	5 - 100	5 - 100	5 - 100	5 - 100	5 - 100
Elevation difference (in / out) Max	m	15/30	15/30 <sup>2)</sup>	15/30 <sup>2)</sup>	15/30 <sup>2)</sup>	15/30 <sup>2)</sup>	30	30
Pre-charged pipe length	m	30	30	30	30	30	30	30
Additional gas amount	g/m	15	30	40	40	40	80	80
Refrigerant [R32] / CO <sub>2</sub> Eq.	kg / T	1,13/0,76	1,95/1,32	2,70/1,82	3,00/2,03	3,00/2,03	4,80/3,24	4,80/3,24
Operating range	Cool Min ~ Max °C	-15 ~ +46	-15 ~ +52	-20 <sup>3)</sup> ~ +52	-20 <sup>3)</sup> ~ +52	-20 <sup>3)</sup> ~ +52	-15 ~ +52	-15 ~ +52
	Heat Min ~ Max °C	-20 ~ +24	-20 ~ +24	-20 ~ +24	-20 ~ +24	-20 ~ +24	-20 ~ +35	-20 ~ +35

1) 5,0 kW with wall-mounted, 7,1 - 14,0 kW with 4 way 90x90 cassette. 20,0 - 25,0 kW with high static pressure hide-away. 2) Outdoor unit located lower / outdoor unit located higher. 3) Pipe length up to 30 m.



## PACi NX Standard outdoor units - R32

		10,0 kW	12,5 kW	14,0 kW
<b>Outdoor unit single phase</b>		<b>U-100PZ3E5</b>	<b>U-125PZ3E5</b>	<b>U-140PZ3E5</b>
<b>Outdoor unit three phase</b>		<b>U-100PZ3E8</b>	<b>U-125PZ3E8</b>	<b>U-140PZ3E8</b>
Cooling capacity <sup>1)</sup>	Nominal (Min - Max) kW	10,0(3,0 - 11,5)	12,5(3,2 - 13,5)	14,0(3,3 - 15,0)
Heating capacity <sup>1)</sup>	Nominal (Min - Max) kW	10,0(3,0 - 14,0)	12,5(3,3 - 15,0)	14,0(3,4 - 16,0)
Power supply	Single phase V	220-230-240	220-230-240	220-230-240
	Three phase V	380-400-415	380-400-415	380-400-415
Connection indoor / outdoor	mm <sup>2</sup>	2x1,5 or 2,5	2x1,5 or 2,5	2x1,5 or 2,5
Air flow	Cool / Heat m <sup>3</sup> /min	73,0/73,0	82,0/80,0	84,0/82,0
Sound pressure	Cool / Heat (Hi) dB(A)	52/52	55/55	56/56
Sound power	Cool / Heat (Hi) dB(A)	70/70	73/73	74/74
Dimension	H x W x D mm	996 x 980 x 370	996 x 980 x 370	996 x 980 x 370
Net weight	kg	83	87	87
	Liquid Inch (mm)	3/8(9,52)	3/8(9,52)	3/8(9,52)
Piping diameter	Gas Inch (mm)	5/8(15,88)	5/8(15,88)	5/8(15,88)
	Min - Max m	5 - 50	5 - 50	5 - 50
Elevation difference (in / out) <sup>2)</sup> Max	m	15/30	15/30	15/30
Pre-charged pipe length	m	30	30	30
Additional gas amount	g/m	45	45	45
Refrigerant [R32] / CO <sub>2</sub> Eq.	kg / T	2,4/1,62	2,8/1,89	2,8/1,89
Operating range	Cool Min ~ Max °C	-10 ~ +43	-10 ~ +43	-10 ~ +43
	Heat Min ~ Max °C	-15 ~ 24	-15 ~ 24	-15 ~ 24

1) With 4 way 90x90 cassette. 2) Outdoor unit located lower / outdoor unit located higher.



## Compatible indoor units for multi combinations

Optional:

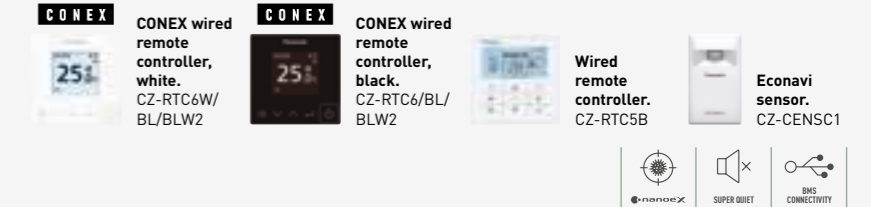

Wall-mounted - PK4	Indoor unit	Cooling capacity kW	Heating capacity kW	Dimension H x W x D mm	Sound pressure <sup>1)</sup> dB(A)		Air flow <sup>2)</sup> m <sup>3</sup> /min	
					Hi / Med / Lo	Hi / Med / Lo		
2,5 - 4,5 kW	S-2545PK4E	2,5-5,0	2,8-5,6	290x765x214	39/34/29 - 41/36/30 - 41/36/31	10,5/19,0/17,0 - 11,5/19,5/7,0 - 17,0/15,5/12,0		
5,0 - 7,1 kW	S-5010PK4E	6,1-7,1	6,1-7,8	295x1060x249	47/44/40 - 47/44/40	21,0/19,0/16,5 - 21,0/19,0/16,5		
10,0 kW	S-5010PK4E	9,5	9,5	295x1060x249	49/45/41	22,5/20,0/17,5		

Panels (sold separately):



4 way 60x60 cassette - PY3	Indoor unit (panel CZ-KPY4)	Cooling capacity kW	Heating capacity kW	Dimension indoor / panel H x W x D mm	Sound pressure <sup>1)</sup> dB(A)		Air flow <sup>2)</sup> m <sup>3</sup> /min	
					Hi / Med / Lo	Hi / Med / Lo		
2,5 kW	S-25PY3E	2,5	3,2	243x575x575 / 30x625x625	31/28/25	8,5/7,0/6,0		
3,6 kW	S-36PY3E	3,6	4,0	243x575x575 / 30x625x625	34/30/25	9,5/7,5/6,0		
5,0 kW	S-50PY3E	5,0	5,6	243x575x575 / 30x625x625	39/34/27	12,0/9,5/6,5		
6,0 kW	S-60PY3E	6,0	7,0	243x575x575 / 30x625x625	43/37/31	14,0/10,5/8,0		

Panels (sold separately):

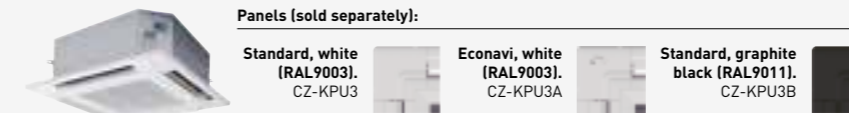

4 way 90x90 cassette - PU3	Indoor unit (panels CZ-KPU3 / CZ-KPU3B / CZ-KPU3A)	Cooling capacity kW	Heating capacity kW	Dimension indoor / panel H x W x D mm	Sound pressure <sup>1)</sup> dB(A)		Air flow <sup>2)</sup> m <sup>3</sup> /min	
					Hi / Med / Lo	Hi / Med / Lo		
3,6 - 5,0 kW	S-3650PU3E	3,6-5,0	4,0-5,6	256x840x840 / 33,5x950x950	30/28/27 - 32/29/27	14,5/13,0/11,5 - 16,5/13,5/11,5		
6,0 - 7,1 kW	S-6071PU3E	6,0-7,1	7,0-8,0	256x840x840 / 33,5x950x950	36/31/28 - 37/31/28	21,0/16,0/13,0 - 22,0/16,0/13,0		
10,0 - 12,5 kW	S-1014PU3E	10,0-12,5	11,2-14,0	319x840x840 / 33,5x950x950	45/38/32 - 46/39/33	36,0/26,0/18,0 - 37,0/27,0/19,0		
14,0 kW	S-1014PU3E	14,0	16,0	319x840x840 / 33,5x950x950	47/40/34	38,0/29,0/20,0		



Ceiling - PT3	Indoor unit	Cooling capacity kW	Heating capacity kW	Dimension H x W x D mm	Sound pressure <sup>1)</sup> dB(A)		Air flow <sup>2)</sup> m <sup>3</sup> /min	
					Hi / Med / Lo	Hi / Med / Lo		
3,6 - 5,0 kW	S-3650PT3E	3,5-5,0	4,0-5,6	235x960x690	36/32/28 - 37/33/28	14,0/12,0/10,5 - 15,0/12,5/10,5		
6,0 - 7,1 kW	S-6071PT3E	6,0-6,8	7,0-8,0	235x1275x690	38/34/29 - 39/35/30	20,0/17,0/14,5 - 21,0/18,0/15,5		
10,0 - 12,5 kW	S-1014PT3E	9,5-12,1	11,2-14,0	235x1590x690	42/37/34 - 46/40/35	30,0/25,0/23,0 - 34,0/28,0/24,0		
14,0 kW	S-1014PT3E	13,4	16,0	235x1590x690	47/41/36	35,0/29,0/25,0		



Adaptive ducted unit - PF3	Indoor unit	Cooling capacity kW	Heating capacity kW	Dimension H x W x D mm	External static pressure Nominal (Min - Max) Pa	Sound pressure <sup>1)</sup> dB(A)		Air flow <sup>2)</sup> m <sup>3</sup> /min	
						Hi / Med / Lo	Hi / Med / Lo		
3,6 - 5,0 kW	S-3650PF3E	3,6-5,0	4,0-5,6	250x800x730	30(10-150) - 30(10-150)	30/27/22 - 34/30/25	14,0/13,0/10,0 - 16,0/15,0/12,0		
6,0 - 7,1 kW	S-6071PF3E	5,7-6,8	7,0-7,5	250x1000x730	30(10-150) - 30(10-150)	30/26/23 - 30/26/23	21,0/19,0/15,0 - 21,0/19,0/15,0		
10,0 - 12,5 kW	S-1014PF3E	9,5-12,1	10,8-13,5	250x1400x730	40(10-150) - 50(10-150)	33/29/25 - 35/31/27	32,0/26,0/21,0 - 34,0/29,0/23,0		
14,0 kW	S-1014PF3E	13,4	15,5	250x1400x730	50(10-150)	39/35/29	36,0/32,0/25,0		

\*The data shown in these tables are based on PACi NX Elite combinations. 1) The sound pressure is measured in accordance with Eurovent 6/C/006-97 specification. 2) Factory setting.

# Simultaneous operation system combinations

## PACi NX Elite from 5,0 to 25,0 kW simultaneous operation system combinations - R32<sup>1)</sup>

Capacity	Indoor	Outdoor						
		5,0 kW	7,1 kW	10,0 kW	12,5 kW	14,0 kW	20,0 kW	25,0 kW
2,5 kW	S-25PY3E S-2545PK4E	Twin U-50	Triple U-71	Double-twin U-100				
3,6 kW	S-36PY3E S-3650PF3E S-2545PK4E S-3650PT3E S-3650PU3E	Twin U-71	Triple U-100	Double-twin U-125				
4,5 kW	S-3650PF3E S-2545PK4E S-3650PT3E S-3650PU3E		Triple U-125					
5,0 kW	S-50PY3E S-3650PF3E S-5010PK4E S-3650PT3E S-3650PU3E	Twin U-100	Triple U-140	Double-twin U-200				
6,0 kW	S-60PY3E S-6071PF3E S-5010PK4E S-6071PT3E S-6071PU3E		Twin U-125	Double-twin U-250				
7,1 kW	S-6071PF3E S-5010PK4E S-6071PT3E S-6071PU3E		Twin U-140	Triple U-200				
10,0 kW	S-1014PF3E S-5010PK4E S-1014PU3E			Twin U-200				
12,5 kW	S-1014PF3E S-1014PU3E				Twin U-250			

## PACi NX Standard from 10,0 to 14,0 kW simultaneous operation system combinations - R32

Capacity	Indoor	Outdoor	
		10,0 kW	14,0 kW
5,0 kW	S-50PY3E S-3650PF3E S-5010PK4E S-3650PT3E S-3650PU3E	Twin U-100	
6,0 kW	S-60PY3E S-6071PF3E S-5010PK4E S-6071PT3E S-6071PU3E	Twin U-125	
7,1 kW	S-6071PF3E S-5010PK4E S-6071PT3E S-6071PU3E		Twin U-140

1) 7,1 - 14,0 kW: Available with indoor unit types PY3, PF3, PK4, PT3, and PU3. 20,0 - 25,0 kW: Available with indoor unit types PF3, PU3 and PK4.

# Refrigerant piping arrangements

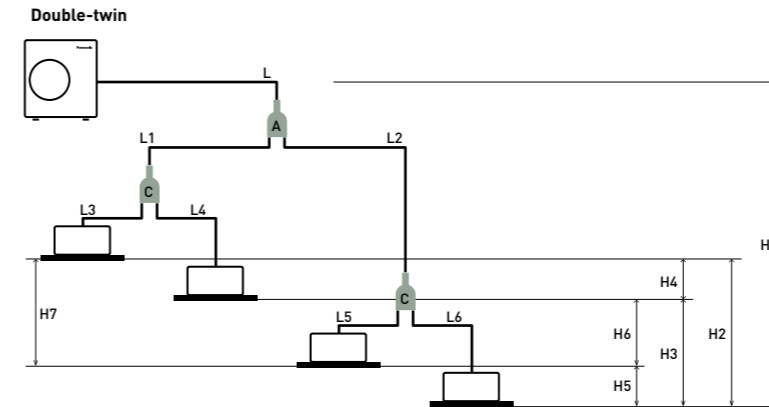
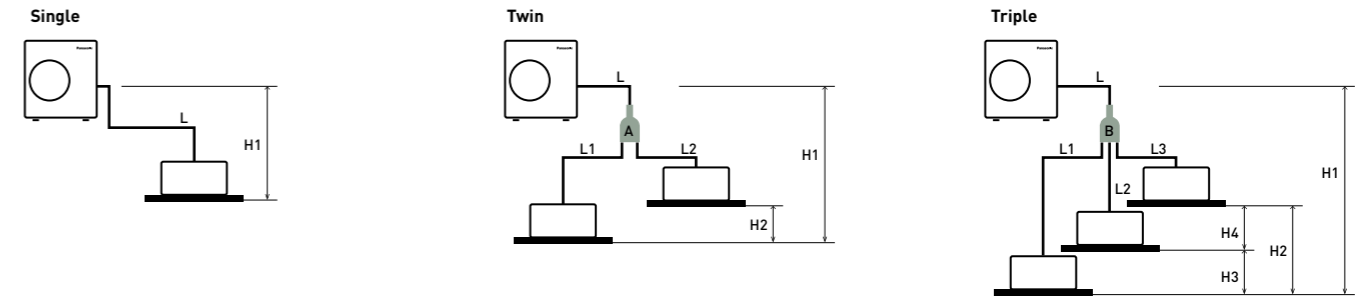

**PACi NX Elite twin, triple and double-twin system from 5,0 to 14,0 kW**  
 Joint distribution (sold separately)  
 A= CZ-P224BK2BM  
 B= CZ-P3 HPC2BM  
 C= CZ-P224BK2BM

**Big PACi NX Elite twin, triple and double-twin system from 20,0 to 25,0 kW**  
 Joint distribution (sold separately)  
 A= CZ-P680BK2BM  
 B= CZ-P3 HPC2BM  
 C= CZ-P224BK2BM



**PACi NX Standard twin system from 10,0 to 14,0 kW**  
 Joint distribution (sold separately)  
 A= CZ-P224BK2BM

Twin System	PACi NX Standard single and twin system from 7,1 to 14,0 kW			PACi NX Elite twin, triple and double-twin system from 5,0 to 25,0 kW					
	Indoor unit combinations (see examples above)	Equivalent lengths and height differences (m) for outdoor unit sizes...		Indoor unit combinations (see examples above)				Equivalent lengths and height differences (m) for outdoor unit sizes from 5,0 to 14,0 kW	Equivalent lengths and height differences (m) for outdoor unit sizes from 20,0 to 25,0 kW
		Single	Twin	Single	Twin	Triple	Double-twin		
Total pipe length	L	L + L1 + L2	≤ 50 m	L	L + L1 + L2	L + L1 + L2 + L3	L + L1 + L2 + L3 + L4 + L5 + L6	U-50/60: 40 m U-71: 60 m U-100/125/140: ≤ 100 m	U-200/250: ≤ 100 m
Maximum pipe length from outdoor unit to most distant indoor unit	-	-	-	-	L + L1 or L + L2	L + L1 or L + L2 or L + L3	L + L1 + L3 or L + L1 + L4 or L + L2 + L5 or L + L2 + L6	-	U-200: 90 m U-250: 60 m
Maximum branch pipe length	-	L1 L2	≤ 15	-	L1 or L2	L1 or L2 or L3	L1 + L3 or L1 + L4 or L2 + L5 or L2 + L6	≤ 15 m	≤ 20 m
Maximum branch pipe length differences	-	L1 > L2 L1 - L2	≤ 10	-	L1 > L2: L1 - L2	L1 > L2 > L3: L1 - L2 L2 - L3 L1 - L3	L2 + L6 (Max.) L1 + L3 (Min.) (L2 + L6) - (L1 + L3)	≤ 10 m	≤ 10 m
Maximum pipe length differences after first branch (Double-twin)	-	-	-	-	-	-	L2 > L1: L2 - L1	≤ 10 m	≤ 10 m
Maximum pipe length differences after second branch (Double-twin)	-	-	-	-	-	-	L4 > L3: L4 - L3 L6 > L5: L6 - L5	≤ 10 m	≤ 10 m
Height difference (outdoor unit located higher)	H1	H1	≤ 30	H1	H1	H1	H1	≤ 30 m	≤ 30 m
Height difference (outdoor unit located lower)	H1	H1	≤ 15	H1	H1	H1	H1	≤ 15 m	≤ 15 m
Height difference between indoor units	-	H2	≤ 0,5	-	H2	H2 or H3 or H4	H2 or H3 or H4 or H5 or H6	≤ 0,5 m	≤ 0,5 m

Make additional charges by adding up tube length in an order of main tube (L) > branch tube (L1 > L2 > L3 wide diameter) and then selecting the amount of refrigerant corresponding to the remaining (after charge-less tube length: 30 m) liquid tube diameter and tube length from the above table. For pipe sizes and refrigerant charge, please refer to the technical instructions or design software.

# PACi NX – A versatile solution for comfort and specialised cooling applications

Not only delivering efficient heating and cooling for everyday comfort, the PACi NX range is also engineered for critical environments such as wine cellars, server rooms, and museums where performance beyond standard comfort operation is essential.

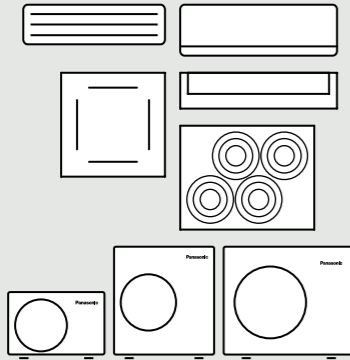
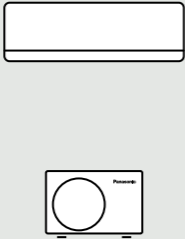
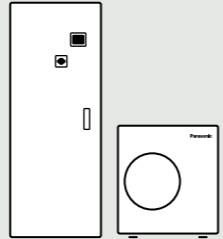
Specialised cooling application	<b>Cold rooms</b> Examples: Wine cellars 	<b>Small server room – 24/7/365 operation</b> 	<b>Small critical environment</b> Examples: Museum, laboratory 
			
<b>PACi NX solution</b>	<b>Low temperature unit configuration</b> Cooling operation down to 8 °C. Flexibility with different type of indoors and controllers. nanoe™ X to improve indoor air quality.	<b>YKEA Series</b> Cooling operation down to -25 °C. Redundancy control options. Exceptional efficiency: SEER 9,6 (A+++)*. <small>*Model: 3,5 kW.</small>	<b>P Series</b> Close control solution for precise cooling. Strict control of temperature and humidity. Advanced control with integrated Modbus.
<b>Capacity range</b>	<b>3,5 kW – 23,2 kW</b>	<b>2,5 kW – 7,1 kW</b>	<b>7,5 kW – 20,5 kW</b>

# PACi NX Elite can cool rooms down to 8 °C

Panasonic PACi NX Elite offers a high quality and efficient solution for high temperature refrigeration applications for facilities such as wine cellars, food processing facilities and supermarkets.

REFER TO PAGE 650 FOR DETAILED SPECIFICATIONS 

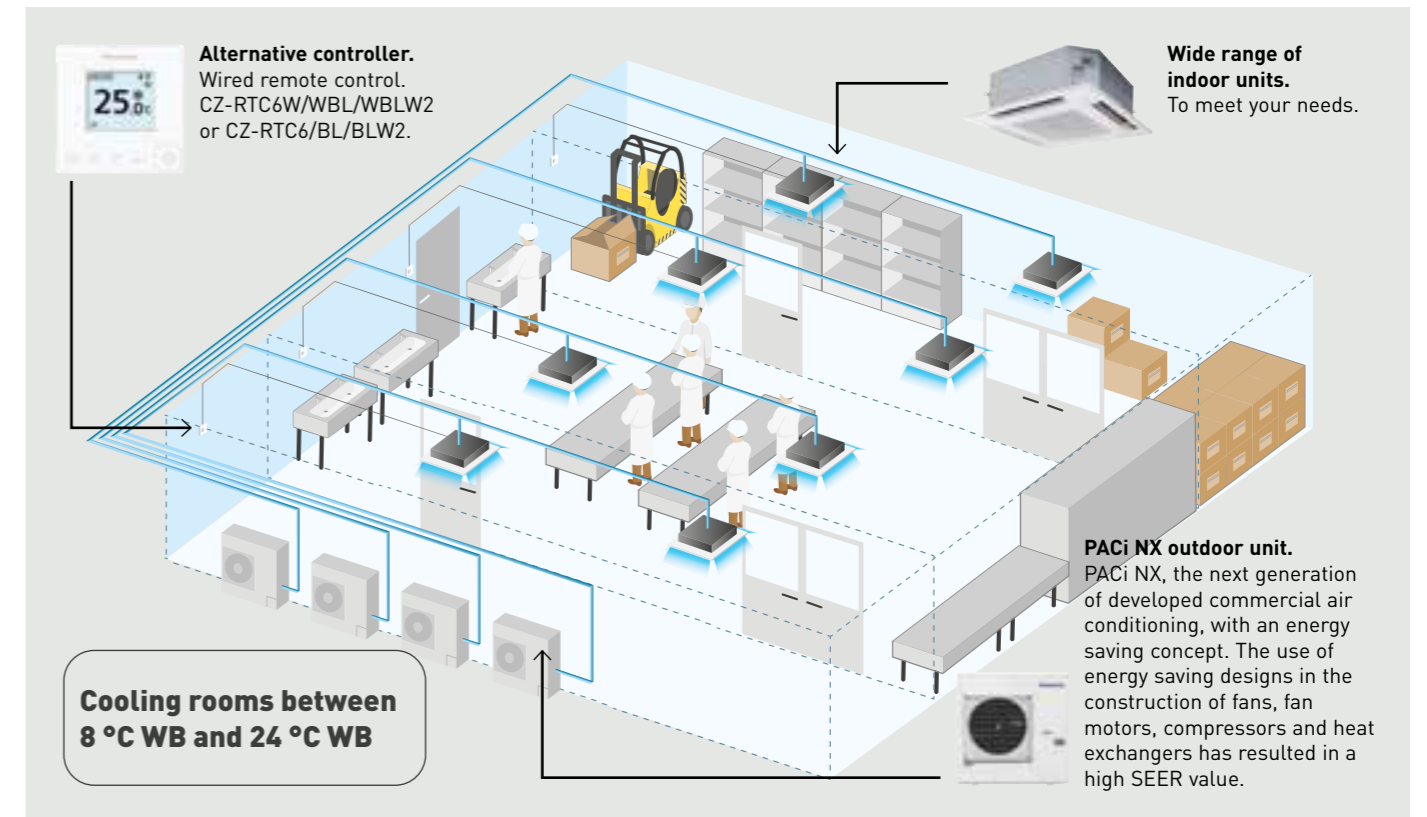

- Flexibility with different type of indoors
- Benefits of hydroxyl radicals
- Provides wide scale of control options (individual, central, remote multi-site monitoring)
- Redundancy for 2 systems with CONEX controller range and up to 4 indoor unit groups with PAW-PACR4 optional redundancy controller



## Wine cellars and special high temperature rooms

One of the main features of the PACi NX series is the possibility of adjusting the product for special applications, not just for regular cooling applications. The purpose of this product information is to explain in detail these special applications that need a cooling operation to maintain the room temperature at +8 ~ +24 °C WB (or +10 ~ +30 °C DB). In order to do this in terms of enthalpy, the indoor unit needs to be overdimensioned and certain parameters need to be adjustable.

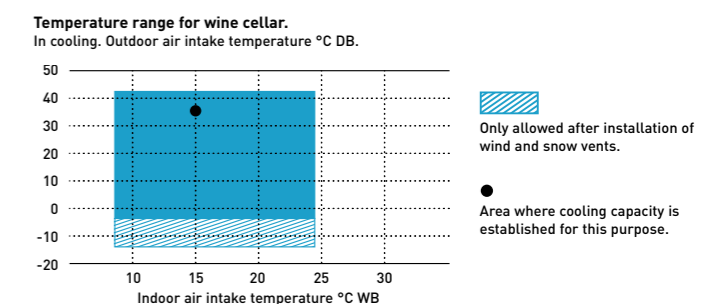

Temperature range		
	Indoor	Outdoor
Cooling operation	+8 ~ +24 °C WB	-5 [-15] ~ 43 °C DB

# YKEA series for server rooms

## High-efficiency products for 24/7 applications.

Panasonic has developed a complete range of solutions for server rooms which efficiently protect your servers, keeping them at an appropriate temperature even when the outdoor temperature is below -25 °C.



**1 Designed for 24h/7d a week operation**  
High-efficiency all year round. This wall-mounted air conditioner is designed for professional, critical applications such as computer rooms where reliable cooling inside the room is necessary even with extreme ambient conditions.

**2 Highest energy rating in cooling**  
The SEER and SCOP of the Server room unit has been further improved to achieve top class energy efficiency. The 3,5 kW unit reaches now the SEER value of 9,6 (A+++).

**3 Built-in Wi-Fi and compatible with Voice Assistant**  
The unit is ready to connect to the internet and to be controlled by smartphone with Panasonic Comfort Cloud App. Control, monitor energy consumption statistics and easily identify errors in case of failure.

### Redundancy ensured by three different functionalities.

Computer and server rooms are very sensitive areas of application. Any downtime caused by high room temperatures must be avoided by any means. Air conditioner redundancy is one of the key points to ensure a reliable nonstop cooling operation.

**1 | Backup operation.**  
If one air conditioner stops, another automatically takes over to maintain cooling.

**2 | Support operation.**  
If one unit can't meet demand, another starts automatically to assist.

**3 | Rotation operation.**  
The system rotates between main and backup units to balance operating hours, providing continuous and efficient performance.

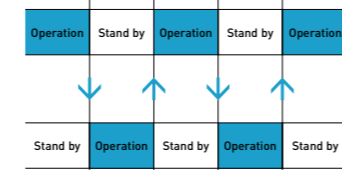
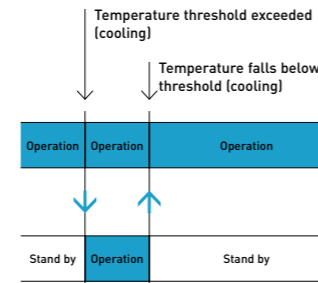
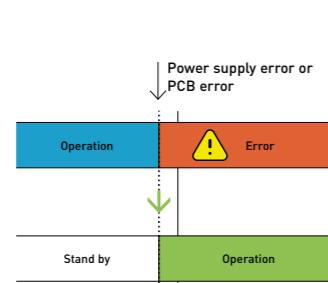
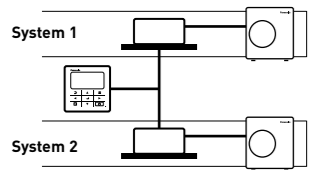

**4 Remote controller for better usability**  
Wired remote controller, which can assure the operation 24/7 of two server room units, thanks to the integrated duty rotation mode. This function manages rotation and backup of two units and it is available when connecting an optional CN-CNT cable (CZ-RCC5) between the controller and each of the two indoor units.

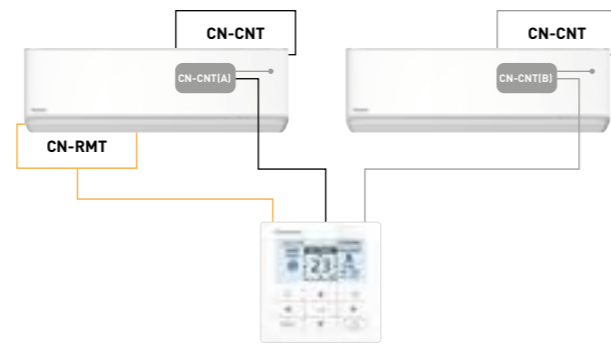

## Wall-mounted Professional YKEA -25 °C · R32

- Designed for 24h/7d a week operation
- Wired remote controller, with optional duty rotation mode
- Improved SEER / SCOP to achieve top class energy efficiency
- Aerowings 2.0, for a better control of the air flow
- Built-in Wi-Fi for smart control via Panasonic Comfort Cloud App
- Compatible with Google Assistant and Amazon Alexa
- Chassis and parts designed for easier installation

KIT			KIT-Z25-YKEA-1	KIT-Z35-YKEA-1	KIT-Z42-YKEA-1	KIT-Z50-YKEA-1	KIT-Z71-YKEA-1
Cooling capacity	Nominal (Min - Max)	kW	2,50 [0,85 - 3,50]	3,50 [0,85 - 4,20]	4,20 [0,85 - 5,00]	5,00 [0,98 - 6,00]	7,10 [0,98 - 8,50]
EER <sup>1)</sup>	Nominal (Min - Max)	W/W	4,90 [4,72 - 3,98]	4,12 [4,72 - 3,68]	3,82 [4,72 - 3,25]	3,68 [3,92 - 3,16]	3,23 [2,33 - 2,83]
<b>SEER <sup>2)</sup></b>			<b>9,5 A+++</b>	<b>9,6 A+++</b>	<b>8,6 A+++</b>	<b>8,6 A+++</b>	<b>6,5 A++</b>
Pdesign		kW	2,50	3,50	4,20	5,00	7,10
Input power	Nominal (Min - Max)	kW	0,51 [0,18 - 0,88]	0,85 [0,18 - 1,14]	1,10 [0,18 - 1,54]	1,36 [0,25 - 1,90]	2,20 [0,42 - 3,00]
Annual energy consumption <sup>3)</sup>		kWh/a	92	128	171	203	382
Heating capacity	Nominal (Min - Max)	kW	3,40 [0,85 - 5,00]	4,00 [0,85 - 5,80]	5,30 [0,85 - 6,80]	5,80 [0,98 - 8,00]	8,20 [0,98 - 10,20]
Heating capacity at -7 °C		kW	3,05	3,40	4,11	4,80	6,31
COP <sup>1)</sup>	Nominal (Min - Max)	W/W	4,86 [4,72 - 3,97]	4,44 [4,72 - 3,87]	3,93 [4,72 - 3,66]	4,08 [4,26 - 3,35]	3,71 [2,45 - 3,29]
<b>SCOP <sup>2)</sup></b>			<b>4,6 A++</b>	<b>4,6 A++</b>	<b>4,5 A+</b>	<b>4,6 A++</b>	<b>4,1 A+</b>
Pdesign at -10 °C		kW	2,70	3,20	3,60	4,20	5,50
Input power	Nominal (Min - Max)	kW	0,70 [0,18 - 1,26]	0,90 [0,18 - 1,50]	1,35 [0,18 - 1,86]	1,42 [0,23 - 2,39]	2,21 [0,40 - 3,10]
Annual energy consumption <sup>3)</sup>		kWh/a	822	974	1120	1278	1878
<b>Indoor unit</b>			<b>CS-Z25YKEA-1</b>	<b>CS-Z35YKEA-1</b>	<b>CS-Z42YKEA-1</b>	<b>CS-Z50YKEA-1</b>	<b>CS-Z71YKEA-1</b>
Power supply		V	230	230	230	230	230
Recommended fuse		A	16	16	16	16	20
Connection indoor / outdoor		mm <sup>2</sup>	4x1,5	4x1,5	4x1,5	4x2,5	4x2,5
Air flow	Cool / Heat	m <sup>3</sup> /min	11,4/13,8	12,7/14,8	13,2/15,2	17,4/19,1	19,0/19,9
Moisture removal volume		L/h	1,5	2,0	2,4	2,8	4,1
Sound pressure <sup>4)</sup>	Cool (Hi / Lo / Q-Lo)	dB(A)	39/25/21	42/28/21	43/32/29	44/37/30	47/38/35
	Heat (Hi / Lo / Q-Lo)	dB(A)	41/27/22	43/30/22	44/35/29	44/37/30	47/38/35
Sound power	Cool / Heat (Hi)	dB(A)	55/57	58/59	59/60	60/60	63/63
Dimension / Net weight	H x W x D	mm / kg	295 x 870 x 229 / 11	295 x 870 x 229 / 11	295 x 870 x 229 / 11	295 x 1040 x 244 / 12	295 x 1040 x 244 / 13
<b>Outdoor unit</b>			<b>CU-Z25YKEA-1</b>	<b>CU-Z35YKEA-1</b>	<b>CU-Z42YKEA-1</b>	<b>CU-Z50YKEA-1</b>	<b>CU-Z71YKEA-1</b>
Air flow	Cool / Heat	m <sup>3</sup> /min	27,6/27,6	29,8/29,8	29,8/31,0	39,8/36,9	44,7/45,8
Sound pressure <sup>4)</sup>	Cool / Heat (Hi)	dB(A)	46/48	48/50	48/51	48/50	52/54
Sound power	Cool / Heat (Hi)	dB(A)	61/63	63/65	63/66	63/65	66/68
Dimension <sup>5)</sup> / Net weight	H x W x D	mm / kg	542 x 780 x 289 / 30	542 x 780 x 289 / 30	542 x 780 x 289 / 30	695 x 875 x 320 / 40	695 x 875 x 320 / 45
Piping diameter	Liquid	Inch (mm)	1/4 (6,35)	1/4 (6,35)	1/4 (6,35)	1/4 (6,35)	1/4 (6,35)
	Gas	Inch (mm)	3/8 (9,52)	3/8 (9,52)	1/2 (12,70)	1/2 (12,70)	5/8 (15,88)
Pipe length range / Elevation difference (in / out)		m / m	3 - 20 / 15	3 - 20 / 15	3 - 20 / 15	3 - 30 / 15	3 - 30 / 20
Pre-charged pipe length / Additional gas amount		m / g/m	7,5 / 10	7,5 / 10	7,5 / 10	7,5 / 15	10 / 25
Refrigerant [R32] / CO <sub>2</sub> Eq.		kg / T	0,89 / 0,60	0,89 / 0,60	0,97 / 0,65	1,13 / 0,76	1,35 / 0,91
Operating range	Cool Min - Max	°C	-25 ~ +43	-25 ~ +43	-25 ~ +43	-25 ~ +43	-25 ~ +43
	Heat Min - Max	°C	-15 ~ +24	-15 ~ +24	-15 ~ +24	-15 ~ +24	-15 ~ +24

1) EER and COP calculation is based in accordance to EN 14511. 2) Energy Label Scale from A+++ to D. 3) The annual energy consumption is calculated in accordance to EU/626/2011. 4) The sound pressure of the indoor unit shows the value measured at a position 1 m in front of the main body and 0,8 m below the unit. For outdoor unit 1 m in front and 1 m in rear side of main body. The sound pressure is measured in accordance with JIS C 9612. Q-Lo: Quiet mode. Lo: The lowest set fan speed. 5) Add 70 mm for piping port. \*Not compatible with PACi NX outdoors and accessories. Domestic range sales conditions may apply. Check with your sales representative.

Accessories	
<b>CZ-RCC5</b>	CN-CNT cables x2 for server room application, control of 2 units, rotation, backup, etc.
<b>PAW-SERVER-PKEA-1</b>	Redundancy of 2 units YKEA-1. SG Ready.
<b>PAW-WTRAY</b>	Tray for condenser water compatible with outdoor elevation platform

Accessories	
<b>PAW-GRDBSE20</b>	Outdoor base ground support for noise and vibration absorption
<b>PAW-GRDSTD40</b>	Outdoor elevation platform 400 x 900 x 400 mm

### Optional interface for YKEA units.

**PAW-SERVER-PKEA-1**  
· Ideal solution for small server rooms, providing full redundancy functionality  
· Up to 2 YKEA systems connectable to PAW-SERVER-PKEA-1  
· Additional benefits: Operation and alarm outputs for each system, ON / OFF inputs for each system for connection to external BMS

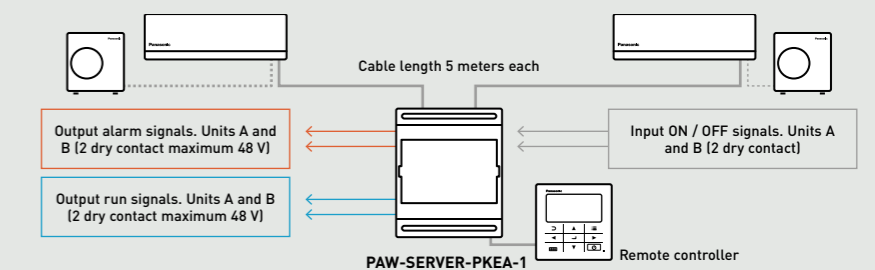

R32 REFRIGERANT | A+++ 9,6 SEER | A++ 4,6 SCOP | INVERTER | R32 ROTARY COMPRESSOR | 21 dB(A) | AEROWINGS | -25 °C COOLING MODE | -15 °C HEATING MODE | R32 R410A R32 R410A RENEWAL | INTEGRATION TO S-LINK | BUILT-IN WI-FI | BMS CONNECTIVITY | 5 YEARS COMPRESSOR WARRANTY

SEER: For KIT-Z35-YKEA-1. SCOP: For KIT-Z25-YKEA-1, KIT-Z35-YKEA-1 and KIT-Z50-YKEA-1. SUPER QUIET: For KIT-Z25-YKEA-1. INTERNET CONTROL: Built-in Wi-Fi.

# Close Control P Series for small critical environments

Precise cooling solution for a strict control of temperature and humidity in small critical environments. Efficiency, energy saving and flexibility.



**COMPLETE PACKAGE SOLUTION**

**SOLUTION FOR SMALL CRITICAL ENVIRONMENT**

**R32 LOW GWP SOLUTION**

### Strict control of temperature and humidity

Comprehensive split solution designed to maintain stable temperature and humidity in small critical environments such as laboratories, museums and archives, server rooms.

### SMART net - Load balancing and uninterrupted operation

The system supports advanced Local Area Network (LAN) configuration with up to 12 units in cascade. The SMART net system ensures precise climate control through intelligent load balancing and synchronized temperature and humidity regulation. Built-in redundancy and automatic failover guarantee continuous operation, minimizing downtime.

**Up to 12 units in cascade**

**x12**

### Built-in advanced control with integrated Modbus.

The advanced control system offers full Modbus control to deliver optimum performance and easier access to information. A predictive safety system is designed to prevent unwanted shut-downs.



Wide full graphic LCD colour display.

### Product configurations

Model - Up flow (T-OPZ)	0071AA-E001	0111AA-E001	0121AA-E001	0141AA-E001	0211AA-E001	0071AA-E002	0111AA-E002	0121AA-E002	0141AA-E002	0211AA-E002	0071AA-E003	0111AA-E003	0121AA-E003	0141AA-E003	0211AA-E003
Model - Down flow (T-UPZ)	0071AA-E001	0111AA-E001	0121AA-E001	0141AA-E001	0211AA-E001	0071AA-E002	0111AA-E002	0121AA-E002	0141AA-E002	0211AA-E002	0071AA-E003	0111AA-E003	0121AA-E003	0141AA-E003	0211AA-E003
Humidifier	3 kg/h	-	-	-	-	0	0	0	0	0	0	0	0	0	0
	8 kg/h	-	-	-	-	-	-	-	-	-	0	0	0	0	0
Modulating heater	6 kW	-	-	-	-	-	-	-	-	-	0	0	0	0	-
	9 kW	-	-	-	-	-	-	-	-	-	-	-	-	0	0

**NEW**

**NEW! P Series - Perimetral · R32**

**First complete package solution for critical environment up to 21 kW.**

- Close-control solution for precise cooling
- Strict control of temperature and humidity
- Version with humidifier and modulating heater

Sizes			71	111	121	141	211	211
Indoor unit	Up flow	T-OPZ	0071AA-E004	0111AA-E004	0121AA-E004	0141AA-E004	0211AA-E004	0211AA-E005
Indoor unit	Down flow	T-UPZ	0071AA-E004	0111AA-E004	0121AA-E004	0141AA-E004	0211AA-E004	0211AA-E005
Cooling capacity <sup>1)</sup>		kW	7,44	9,92	12,50	14,71	20,47	20,47
Sensible cooling capacity <sup>1)</sup>		kW	6,89	8,41	10,67	12,60	20,47	20,47
<b>EER <sup>2)</sup></b>			<b>3,52</b>	<b>3,13</b>	<b>2,79</b>	<b>2,61</b>	<b>2,38</b>	<b>2,38</b>
Air flow		m <sup>3</sup> /h	2.200	3.500	3.500	3.500	7.000	7.000
Sound pressure		dB(A)	51	59	59	59	56	56
Dimension	Height	mm	1990	1990	1990	1990	1990	1990
	Width	mm	750	750	750	750	860	860
	Depth	mm	600	600	600	600	880	880
Overall weight		kg	150	200	205	205	225	225
<b>Fan</b>								
Fan type			EC	EC	EC	EC	EC	EC
Quantity			1	1	1	1	1	1
Power supply	Voltage	V	230	400	400	400	400	400
	Phase		Single phase	Three phase	Three phase	Three phase	Three phase	Three phase
	Frequency	Hz	50	50	50	50	50	50
Maximum power consumption		kW	0,50	1,10	1,10	1,10	1,50	1,50
Maximum volume airflow		m <sup>3</sup> /h	2600	3500	3500	3500	8000	8000
Maximum pressure		Pa	700	570	570	570	900	900
<b>Humidifier</b>								
Humidifier		kg/h	3,0	3,0	3,0	3,0	3,0	8,0
Quantity			1,0	1,0	1,0	1,0	1,0	1,0
Cylinder volume		l	3,3	3,3	3,3	3,3	3,3	5,4
Instantaneous supply flow rate		l/min	0,6	0,6	0,6	0,6	0,6	0,6
Instantaneous discharge flow rate		l/min	10,0	10,0	10,0	10,0	10,0	10,0
<b>Heater</b>								
Maximum power		kW	6	6	6	6	9	9
Power supply	Voltage	V	400	400	400	400	400	400
	Phase		Three phase	Three phase	Three phase	Three phase	Three phase	Three phase
	Frequency	Hz	50	50	50	50	50	50
Maximum current		A	11,3	11,3	11,3	11,3	17,0	17,0
PACi NX outdoor combination	Single phase	U-71PZH4E5	U-100PZH4E5	U-125PZH4E5	U-140PZH4E5	—	—	—
	Three phase	U-71PZH4E8	U-100PZH4E8	U-125PZH4E8	U-140PZH4E8	U-250PZH4E8	U-250PZH4E8	—

1) Performance refers to: indoor ambient temperature 27 °C DB / 19 °C WB, outdoor ambient temperature 35 °C; R32 refrigerant; The declared performance does not consider the heat generated by the fans, which must be added to the thermal load of the system. 2) EER (energy efficiency ratio) = total cooling capacity / input power of the PACi NX condenser + input power of the fans and CRAC indoor unit. 3) Outdoor unit located lower / outdoor unit located higher. 4) Pipe length up to 30 m.

### PACi NX outdoor combination

Outdoor unit single phase	U-71PZH4E5	U-100PZH4E5	U-125PZH4E5	U-140PZH4E5	—		
Outdoor unit three phase	U-71PZH4E8	U-100PZH4E8	U-125PZH4E8	U-140PZH4E8	U-250PZH4E8		
Power supply	Single phase	V	220 - 230 - 240	220 - 230 - 240	220 - 230 - 240	220 - 230 - 240	—
	Three phase	V	380 - 400 - 415	380 - 400 - 415	380 - 400 - 415	380 - 400 - 415	380 - 400 - 415
Sound pressure	Cool / Heat (Hi)	dB(A)	48/50	52/52	55/55	54/54	57/63
Sound power	Cool / Heat (Hi)	dB(A)	65/67	70/70	73/73	74/74	76/82
Dimension	H x W x D	mm	996 x 980 x 370	996 x 980 x 370	996 x 980 x 370	996 x 980 x 370	996 x 1140 x 460
Net weight	1ph / 3ph	kg	66/66	84/82	86/84	86/84	—/109
Piping diameter	Liquid	Inch (mm)	3/8(9,52)	3/8(9,52)	3/8(9,52)	3/8(9,52)	1/2(12,70)
	Gas	Inch (mm)	5/8(15,88)	5/8(15,88)	5/8(15,88)	5/8(15,88)	7/8(22,22)
Pipe length range	Min ~ Max	m	5 - 60	5 - 100	5 - 100	5 - 100	5 - 100
Elevation difference (in / out)	Max	m	15/30 <sup>3)</sup>	15/30 <sup>3)</sup>	15/30 <sup>3)</sup>	15/30 <sup>3)</sup>	30
Pre-charged pipe length		m	30	30	30	30	30
Additional gas amount		g/m	45	45	45	45	80
Refrigerant (R32) / CO <sub>2</sub> Eq.		kg / T	1,95/1,32	2,70/1,82	3,00/2,03	3,00/2,03	4,80/3,24
Operating range	Cool Min ~ Max	°C	-15 ~ +52	-20 <sup>4)</sup> ~ +52	-20 <sup>4)</sup> ~ +52	-20 <sup>4)</sup> ~ +52	-15 ~ +52
	Heat Min ~ Max	°C	-20 ~ +24	-20 ~ +24	-20 ~ +24	-20 ~ +24	-20 ~ +35
<b>Electrical information (power supply to outdoor)</b>		<b>kW</b>	<b>7,1</b>	<b>10,0</b>	<b>12,5</b>	<b>14,0</b>	<b>25,0</b>
Recommended fuse	Single phase	A	25	35	40	40	—
	Three phase	A	16	16	16	16	30
Connection in. / out.	Single phase	mm <sup>2</sup>	4x2,5	4x2,5	4x2,5	4x2,5	—
	Three phase	mm <sup>2</sup>	4x2,5	4x2,5	4x2,5	4x2,5	—

**AHU connection kit PAH3M-1 for PACi NX**

CONEX Bluetooth® version (CZ-RTC6BL) is built-in.  
Easy connection and set-up is possible via Bluetooth®.  
0-10 V demand control.



PAW-280PAH3M-1			2,5 kW	3,6 kW	5,0 kW	6,0 kW	7,5 kW	10,0 kW	12,5 kW	14,0 kW	20,0 kW	25,0 kW
Dimension	HxWxD	mm	500x400x150	500x400x150	500x400x150	500x400x150	500x400x150	500x400x150	500x400x150	500x400x150	500x400x150	500x400x150
Net weight		kg	11,5	11,5	11,5	11,5	11,5	11,5	11,5	11,5	11,5	11,5
Piping diameter	Liquid	Inch (mm)	1/4 (6,35)	1/4 (6,35)	1/4 (6,35)	3/8 (9,52)	3/8 (9,52)	3/8 (9,52)	3/8 (9,52)	3/8 (9,52)	3/8 (9,52)	1/2 (12,70)
	Gas	Inch (mm)	1/2 (12,70)	1/2 (12,70)	1/2 (12,70)	5/8 (15,88)	5/8 (15,88)	5/8 (15,88)	5/8 (15,88)	5/8 (15,88)	1 (25,40)	1 (25,40)
Intake temperature of AHU connection kit	Cool Min ~ Max	°C DB	18 ~ 32	18 ~ 32	18 ~ 32	18 ~ 32	18 ~ 32	18 ~ 32	18 ~ 32	18 ~ 32	18 ~ 32	18 ~ 32
	Cool Min ~ Max	°C WB	14 ~ 25	14 ~ 25	14 ~ 25	14 ~ 25	14 ~ 25	14 ~ 25	14 ~ 25	14 ~ 25	—	—
	Heat Min ~ Max	°C	16 ~ 30	16 ~ 30	16 ~ 30	16 ~ 30	16 ~ 30	16 ~ 30	16 ~ 30	16 ~ 30	16 ~ 30	16 ~ 30
<b>With PACi NX Elite</b>												
Cooling capacity		kW	—	3,6	5,0	6,0	7,1	10,0	12,5	14,0	19,0	22,0
Heating capacity		kW	—	4,0	5,6	7,0	8,0	11,2	14,0	16,0	22,4	24,0
Air flow	Min / Max	m³/h	—	540/870	630/990	780/1320	780/1320	900/2160	1140/2280	1200/2400	2160/8000	2160/9000
Pipe length range		m	—	3 ~ 40	3 ~ 40	3 ~ 40	5 ~ 50	5 ~ 85	5 ~ 85	5 ~ 85	5 ~ 100	5 ~ 100
Elevation difference (in / out)	Max	m	—	30	30	30	30	30	30	30	30	30
Ambient temperature of outdoor unit	Cool Min ~ Max	°C	—	-15 ~ +46	-15 ~ +46	-15 ~ +46	-15 ~ +46	-20 ~ +48	-20 ~ +48	-20 ~ +48	-15 ~ +52	-15 ~ +52
	Heat Min ~ Max	°C	—	-20 ~ +24	-20 ~ +24	-20 ~ +24	-20 ~ +24	-20 ~ +24	-20 ~ +24	-20 ~ +24	-20 ~ +35	-20 ~ +35
<b>With PACi NX Standard</b>												
Cooling capacity		kW	2,5	3,6	5,0	6,0	7,1	10,0	12,5	14,0	—	—
Heating capacity		kW	3,2	4,0	5,0	6,0	7,1	10,0	12,5	14,0	—	—
Air flow	Min / Max	m³/h	360 / 570	540/870	630/990	780/1320	780/1320	900/2160	1140/2280	1200/2400	—	—
Pipe length range		m	3 ~ 15	3 ~ 15	3 ~ 20	3 ~ 40	3 ~ 40	5 ~ 50	5 ~ 50	5 ~ 50	—	—
Elevation difference (in / out)	Max	m	30	30	30	30	30	30	30	30	—	—
Ambient temperature of outdoor unit	Cool Min ~ Max	°C	-10 ~ +43	-10 ~ +43	-10 ~ +43	-10 ~ +43	-10 ~ +43	-10 ~ +43	-10 ~ +43	-10 ~ +43	—	—
	Heat Min ~ Max	°C	-15 ~ +24	-15 ~ +24	-15 ~ +24	-15 ~ +24	-15 ~ +24	-15 ~ +24	-15 ~ +24	-15 ~ +24	—	—

**Control options**

**Control option 1.**

- The system's control is simple: control of actual suction temperature vs. set point
- Control works in the same way as that of any indoor unit
- Fan signal issued by the PCB (OFF while defrosting, for instance)

**Control option 2.**

- System control by a 0-10 V control working from an external BMS that manages the set point for temperature or capacity. Enhances efficiency by adjusting capacity and enhances comfort as well
- All signals as standard

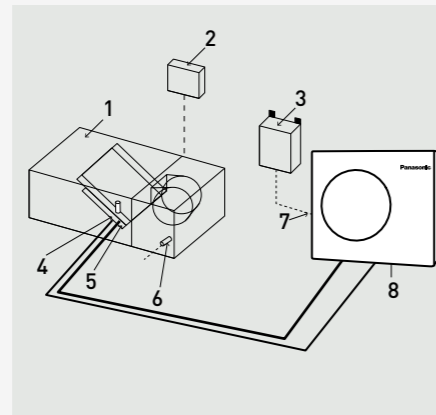

**System and regulations. System overview.**

- 1 | AHU equipment (field supplied)
- 2 | AHU system controller (field supplied)
- 3 | AHU connection kit controller box (with control PCB)
- 4 | Thermistor for gas pipe (E2)
- 5 | Thermistor for liquid pipe (E1)
- 6 | Thermistor for suction air
- 7 | Inter-unit wiring
- 8 | Outdoor unit

**0-10 V control**

With the 0-10 V demand control the capacity of the outdoor unit can be controlled by 20 steps.

Input voltage* [V]	0	1,0	1,5	2,0	2,5	3,0	3,5	4,0	4,5	5,0	5,5	6,0	6,5	7,0	7,5	8,0	8,5	9,0	9,5
Demand [% of nominal current]	No cut <sup>1)</sup>	40	45	50	55	60	65	70	75	80	85	90	95	100	105	110	115	120	No limit / Full capacity <sup>2)</sup>
Indoor unit start / stop	Stop <sup>1)</sup>																		Start

1) No cut / stop: AHU system / indoor unit is completely switched OFF.

2) No limit: No restrictions applied by BMS to AHU system / indoor unit performance [equivalent to "full-load operation" of AHU system / indoor unit].

**AHU connection kit.**



**Optional controller.**



**Electric air curtain**

**Designed to maximize performance:** High air flow upgraded 145% compared to conventional model (in the case of FY-3009U1).

**Comprehensive product line up:** 1,5 m wide model added in the line up.

			FY-3009U1	FY-3012U1	FY-3015U1
Width		mm	900	1200	1500
Voltage		V	220	220	220
Air flow	Hi / Lo	m³/h	1100/920	1400/1270	2000/1800
Consumption	Hi / Lo	W	76/70	94/85	131/110
Current	Hi / Lo	A	0,35/0,32	0,43/0,40	0,59/0,50
Air speed	Hi / Lo	m/s	10,50/8,50	9,50/8,00	10,50/9,50
Sound pressure	Hi / Lo	dB(A)	48,5/45,0	48,5/44,5	51,5/48,0
Dimension	HxWxD	mm	900x231,5x212	1200x231,5x212	1500x231,5x212
Net weight		kg	12,0	14,5	18,0

**Easier installation and maintenance.**

Simple structure for easy installation and maintenance.



**NEW! Air curtain with DX coil, connected to PACi NX systems**

- Advanced defrost control without disrupting the air curtain effect or causing cold drafts
- Flexible installation: suspended as standard, cassette or built-in optional
- Quiet operation



\*Includes two remote controllers: a touch screen remote controller and CZ-RTC6 installed inside of the unit for setup.

Air outlet height 2,8 m			PAW-P2-100R			PAW-P2-150R			PAW-P2-200R			PAW-P2-250R			
Outdoor unit			U-50PZH3E5	U-60PZH3E5	U-71PZH4E5/8	U-100PZH4E5/8	U-100PZH3E5/8	U-125PZH4E5/8	U-125PZH3E5/8	U-140PZH4E5/8	U-200PZH4E8	U-250PZH4E8	U-200PZH4E8	U-250PZH4E8	
Cooling capacity <sup>1)</sup>	Max	kW	5,6	6,3	7,8	11,4	12,0	12,0	11,4	13,6	15,3	16,3	16,3	20,0	20,5
Heating capacity <sup>2)</sup>	Max	kW	6,5	7,0	8,0	12,0	13,0	15,0	12,1	15,0	17,4	20,9	20,9	22,0	25,0
Air flow	High	m <sup>3</sup> /h	1800			2700			3600			4500			
Heat exchanger	Volume	L	1,60			2,80			3,90			5,10			
Electric consumption fan	230 V/50 Hz	kW	0,33			0,50			0,66			0,83			
Current	230 V/50 Hz	A	2,40			3,60			4,80			6,00			
Sound pressure <sup>3)</sup>	Max	dB(A)	56			57			58			59			
Dimension	H x W x D (xD <sup>4)</sup> )	mm	300 x 1000 x 750 (x 890)			300 x 1500 x 750 (x 890)			300 x 2000 x 750 (x 890)			300 x 2500 x 750 (x 890)			
Net weight		kg	61			74			96			138			
Fan type			EC			EC			EC			EC			
Piping diameter <sup>5)</sup>	Liquid / Gas	Inch (mm)	1/4 (6,35) / 1/2 (12,7)	1/4 (6,35) / 1/2 (12,7)	3/8 (9,52) / 5/8 (15,88)	3/8 (9,52) / 5/8 (15,88)	3/8 (9,52) / 5/8 (15,88)	3/8 (9,52) / 5/8 (15,88)	3/8 (9,52) / 5/8 (15,88)	3/8 (9,52) / 5/8 (15,88)	1/2 (12,70) / 7/8 (22,22)	1/2 (12,70) / 7/8 (22,22)	1/2 (12,70) / 7/8 (22,22)	1/2 (12,70) / 7/8 (22,22)	
Maximum pipe length		m	40	40	60	PZH: 60, PZ: 50	PZH: 100, PZ: 50	100	PZH: 60, PZ: 50	PZH: 100, PZ: 50	100	100	100	100	100
Door width		m	1,0			1,5			2,0			2,5			
Refrigerant			R32			R32			R32			R32			

Air outlet height 3,2 m			PAW-P3-100R			PAW-P3-150R			PAW-P3-200R			PAW-P3-250R		
Outdoor unit			U-100PZH4E5/8	U-125PZH4E5/8	U-140PZH4E5/8	U-100PZH4E5/8	U-125PZH4E5/8	U-140PZH4E5/8	U-200PZH4E8	U-250PZH4E8	U-200PZH4E8	U-250PZH4E8	U-200PZH4E8	U-250PZH4E8
Cooling capacity <sup>1)</sup>	Max	kW	10,0			11,4	13,6	13,8	20,0	21,7	20,0	25,2	20,0	25,2
Heating capacity <sup>2)</sup>	Max	kW	12,0			12,0	13,0	15,0	22,0	25,0	22,0	25,0	22,0	25,0
Air flow	High	m <sup>3</sup> /h	2400			3200			4900			5700		
Heat exchanger	Volume	L	1,60			2,80			3,90			5,10		
Electric consumption fan	230 V/50 Hz	kW	0,50			0,66			0,99			1,16		
Current	230 V/50 Hz	A	3,60			4,80			7,20			8,40		
Sound pressure <sup>3)</sup>	Max	dB(A)	58			59			60			61		
Dimension	H x W x D (xD <sup>4)</sup> )	mm	300 x 1000 x 750 (x 890)			300 x 1500 x 750 (x 890)			300 x 2000 x 750 (x 890)			300 x 2500 x 750 (x 890)		
Net weight		kg	65			78			104			145		
Fan type			EC			EC			EC			EC		
Piping diameter <sup>5)</sup>	Liquid / Gas	Inch (mm)	3/8 (9,52) / 5/8 (15,88)			3/8 (9,52) / 5/8 (15,88)			1/2 (12,70) / 7/8 (22,22)			1/2 (12,70) / 7/8 (22,22)		
Maximum pipe length		m	PZH: 60, PZ: 50	PZH: 100, PZ: 50	100	PZH: 60, PZ: 50	PZH: 100, PZ: 50	100	100	100	100	100	100	100
Door width		m	1,0			1,5			2,0			2,5		
Refrigerant			R32			R32			R32			R32		

1) Minimum discharge temperature of 17 °C, with an air intake temperature of 27 °C, evaporation temperature of 6 °C, compressed gas temperature of 48 °C, SH 5 K, SC 15 K. 2) Air intake temperature of 20 °C, refrigerant R32, outside temperature - 0 °C, compressed gas temperature 70 °C, condensation temperature 49 °C (for U50/U60/U71 55 °C, for U200/U250 48 °C), SC 3 K. 3) Measured in distance from 3,0 m. 4) Depth including brackets for cassette mounting and built-in models. For built-in model height changes + 100 mm for the channels. 5) Piping diameter to outdoor unit. Air curtain port connection for all sizes is 1/2 (12,7 mm) / 7/8 (22,00 mm). For smaller models, field-supplied adapters are required to ensure proper pipe connection.

Accessories	
PAW-CDP1	Drain pump kit

**Technical focus**

- Advanced defrost control maintains the air curtain effect without cold drafts
- Four air curtain lengths available: P2 and P3 - 1,0 m, 1,5 m, 2,0 m, and 2,5 m
- Installation height up to 3,2 m
- Flexible installation: suspended as standard, cassette or built-in optional\*
- Includes one user-friendly touchscreen remote controller
- Effortless settings management via touchscreen control
- Optional smart temperature control automatically adjusts to outdoor conditions
- Integrated control with door sensor and BMS ON / OFF functionality
- Scalable setup: group up to 10 units for synchronized operation
- Drain pump optional

\*Cassette type [PAW-P2-100/150/200/250GVP] or built-in type [PAW-P3-100/150/200/250BVP] available upon request.

**Installation heights and three mounting possibilities**

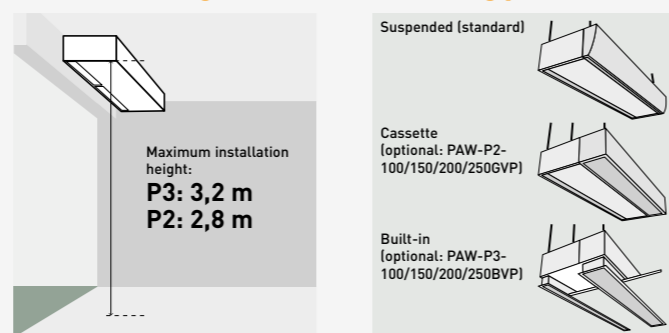

**Ceiling mounted air-e nanoe X Generator**

- nanoe™ X technology (Generator Mark 1: 4,8 trillion hydroxyl radicals/sec)
- Silent operation. Whisper quiet at 25,5 dB(A) (at 230 V)
- Low power consumption 4 W
- Easy installation
- Compact and modern design

Model	FV-15CSD1G		
Power supply	Voltage	V	220
	Frequency	Hz	50
Air flow	m <sup>3</sup> /h	15	16
	CFM	8,8	9,4
Consumption	W	4	4
Sound pressure	dB(A)	23,5	25,5
Net weight	kg	1,1	

\*The value of air volume, power consumption and noise are specified at static pressure 0 Pa. The value of air volume is the mean value and a tolerance of +/-10% is allowed. The value of noise level is a weighted average sound pressure level, the mean value is measured by Panasonic. A tolerance of +3 dB/-7 dB is allowed. The noise is measure at 1 m apart from the front and below of the tested product. Conditions of generating nanoe™ X: room temperature: about 5 °C - 40 °C (dew point temperature more than 2 °C), relative humidity: about 30% - 85%. nanoe™ X is generated using the air in the room, and its amount is subject to the temperature and humidity in the air.

**One device is suitable for around 10 m<sup>2</sup> (with a ceiling height 3 m)**

Ex. 3 air-e devices are required for the room size 30 m<sup>2</sup>.

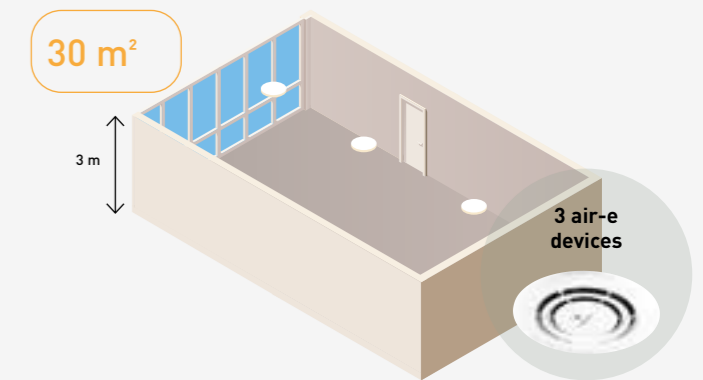

The air-e is a stand alone device which is an easy and simple choice to improve indoor air quality. It can be easily installed to various commercial projects including refurbishments.



**Ceiling mounted air-e nanoe X Generator.**

Bringing nature's balance indoors with Panasonic's unique nanoe™ X technology built into the air-e. Deodorises and inhibits certain bacteria, viruses, mould, pollens and allergens for better indoor air quality.

**The tested effects of nanoe™ X**

**Bacteria and viruses.**

SARS-CoV-2: 99,9% % inhibited <sup>1)</sup>.  
Influenza virus H1N1 subtype: 99,9% inhibited <sup>2)</sup>.

**Odour.**

nanoe X Generator can reduce cigarette smoke odour intensity by 2,4 levels in 12 minutes.

- Novel coronavirus [SARS-CoV-2] > [Test organization] Texcell (France) [Test subject] Adhered novel coronavirus [SARS-CoV-2] [Test volume] 45 L enclosed box [Test result] Inhibited 99,9% in 2 hours [Test report] 1140-01 A1.
- Adhered virus [Influenza virus H1N1 subtype] > [Test organization] Kitasato Research Center for Environmental Science [Test subject] Influenza virus [H1N1 subtype] [Test volume] 1000 L enclosed box [Test result] Inhibited 99,9% in 2 hours [Test report] 21\_0084\_1.
- Deodorisation effect for adhering odour (cigarette smoke) > [Test organization] Panasonic Product Analysis Center [Test subject] Adhered cigarette smoke odour [Test volume] Approx. 24 m<sup>3</sup> laboratory [Test result] Odour intensity reduced 2,4 levels in 0,2 hours [Test report] 4AA33-160615-N04.

Performance of nanoe™ X might differ in real life environment and is only expected in the same room as where the unit is placed. The nanoe™ X performance varies depending on the room size, environment and usage and it may take several hours to reach the full effect. nanoe™ X is not a medical device.

**Deodorisation effect for adhering odour (cigarette smoke) <sup>3)</sup>.**

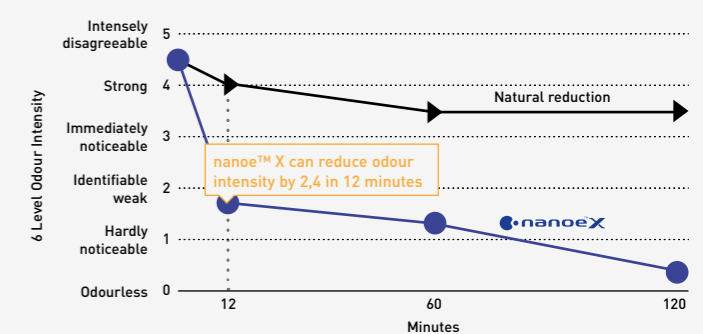

For further details and validation data, please refer to the following website.



## R22 Renewal. Fast, easy to install and cost effective

An important drive to further reduce the potential damage to our ozone.

It is often said that legislation is ruling our lives but sometimes it is there to help save lives. R22 phase out can be described as one of these and from Jan 1st 2010 the use of Virgin R22 refrigerant was banned within the European Union.



### Panasonic is doing its part.

We at Panasonic are also doing our part - recognising that all finances are under pressure at the moment. Panasonic has developed a clean and cost effective solution to enable this latest legislation to offer less financial impact on your business.

The Panasonic renewal system allows good quality existing R22 or R410A pipe work to be re-used whilst installing high-efficiency R32 systems.

By bringing a simple solution to the problem Panasonic can renew all split systems and PACi NX systems; and depending upon certain restrictions we don't even limit the manufacturer's equipment we are replacing.

By installing a high-efficiency Panasonic R32 system you can benefit from around 30% running cost saving compared to the R22 system.

Yes...

1. Check the capacity of the system you wish to replace
  2. Select from the Panasonic range the best system to replace it with
  3. Follow the procedure detailed in the brochure and technical data
- Simple...

### Why renewal?

#### Unique R22 Renewal from Panasonic: Fast, easy to install and cost effective.

- Panasonic refrigerant oil doesn't react to the most common oil types used in air-conditioning systems. This ensures the mix of oil does not damage the units. Therefore installations are easier

- All Panasonic PACi NX units can be installed in R22 pipings, no specific models are available
- Up to 33 Bar! When there is any doubt about the strength of the piping, the maximum working pressure can be reduced to 33 Bar with a setting in the software of the outdoor unit

### Reuse of existing piping (renewal design and installation)

#### Notes on reuse of existing refrigerant piping.

It is possible for each series of PZH and PZ series outdoor unit to reuse the existing refrigerant piping without cleaning when obtained under certain conditions. Make sure that the requirements under the section "Notes on reuse of existing refrigerant piping", "Measurement procedure for renewal" and "Refrigerant piping size and allowable piping length" will be satisfied in order to carry out.

Also, check the items with regard to section "Safety" and "Cleaning".

#### 1. Prerequisite.

- If the refrigerant used for the existing unit is other than R22, R407C and R410A / R32, the existing refrigerant piping cannot be used.
- If the existing unit has another use than air conditioning, then existing refrigerant piping cannot be used.

#### 2. Safety.

- If there is a hollow, crack or corrosion on the piping, make sure to install new piping.
- If the existing piping is other than capable of reuse of piping as shown in the flowchart, make sure to install new piping.
- In case of multiple operation, use our genuine branch piping for refrigerant R32.

A local supplier shall assume responsibility for the defects and hollows on the reuse of existing piping surface and recognition of reliability of the piping strength. There is no guarantee that we take responsibility for such damages.  
The operational pressure of the refrigerant R32 becomes higher compared to R22 or R410A. In the worst case, a lack of compressive strength may lead to piping explosion.

#### 3. Cleaning.

- When the refrigerant oil used for the existing unit is other than the listed below, make sure to install new piping or wash it thoroughly before reusing it.  
[Mineral Oil] SUNISO, FIORE S, MS  
[Synthesized oil] alkyl benzene oil (HAB, parallel freeze), ester oil, ether oil (PVE only)

If the existing unit is GHP type, it is necessary to wash the piping thoroughly.

- If the existing pipes in the outdoor and indoor units remain disconnected, make sure to install a new piping or wash it thoroughly before reusing it.
- If the discoloured oil or residue remains in the existing piping, make sure to install a new piping or wash it thoroughly before reusing it. See "Deterioration Criteria for Refrigerant Oil" in table 3.
- If the compressor of the existing air conditioner has a failure history, make sure to install a new piping or wash it through thoroughly before reusing it.

When reusing the existing piping as it is without removing dirt and dust, inadequate piping could result a renewal appliance in failure.



**Notes on renewal for simultaneous operation of multiple units.**

Only main pipe is applicable for using the different diameter size.  
In case of different diameter size for the branch pipes, a new installation work for a standard size is necessary.  
Be sure to use our genuine branch piping for refrigerant R32.

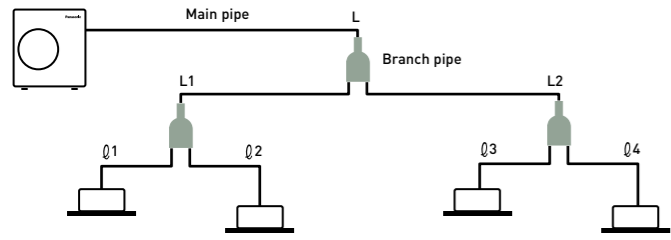

Capacity class	Standard liquid pipe size	Standard gas pipe size
Type 50	Ø 6,35	Ø 12,70
Type from 60 to 140	Ø 9,52	Ø 15,88
Type 200	Ø 12,70	Ø 22,22
Type 250	Ø 12,70	Ø 22,22

**Measurement procedure for renewal**

Observe the following procedure when reusing the existing piping or carrying out renewal installation work.  
Flowchart of existing piping measures criteria for PZH and PZ series outdoor unit.

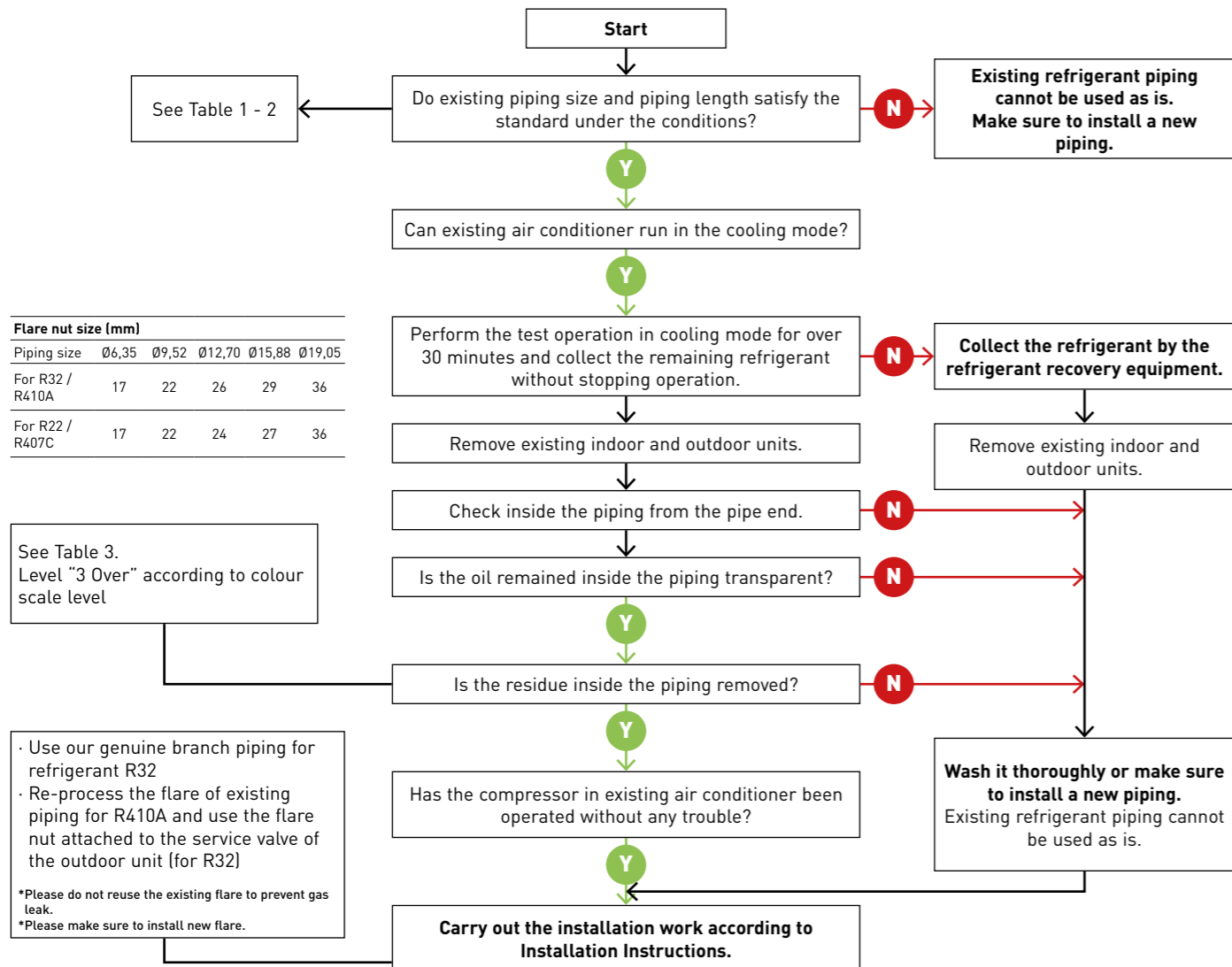

Piping size	Ø6,35	Ø9,52	Ø12,70	Ø15,88	Ø19,05
For R32 / R410A	17	22	26	29	36
For R22 / R407C	17	22	24	27	36

See Table 3. Level "3 Over" according to colour scale level

- Use our genuine branch piping for refrigerant R32
- Re-process the flare of existing piping for R410A and use the flare nut attached to the service valve of the outdoor unit (for R32)

\*Please do not reuse the existing flare to prevent gas leak.  
\*Please make sure to install new flare.

- Only the main pipe L can be used among different diameter's existing piping
- Installation work as a standard size is capable for L1, L2, Ø1 - Ø4 piping
- Be sure to use our genuine branch piping for refrigerant R32

- In case of single unit:
  - It is not necessary to charge with additional refrigerant until the chargeless pipe length in the table 2.
  - If the pipe length is exceeding the charge less pipe length, charge with additional refrigerant amount per 1 m according to the equivalent length.
- In case of simultaneous operation of multiple units:
  - Calculate the refrigerant charging amount according to the calculating method of the standard piping diameter.
  - As to the additional refrigerant charging amount per 1 m, refer to the additional amount in the table 2.

**Refrigerant piping size and allowable piping length.**

Check if reuse of existing refrigerant piping is possible based on the following chart.  
The standards other than this one (difference of elevation, etc.) are identical to the requirements of ordinary refrigerant piping.

**Table 1 - Reusable existing piping (mm)**

Material	0				1/2 H, H*			
External diameter	Ø6,35	Ø9,52	Ø12,70	Ø15,88	Ø19,05	Ø22,22	Ø25,40	Ø28,58
Thickness	0,80	0,80	0,80	1,00	1,00	1,00	1,00	1,00

\*It is impossible to reuse the size of Ø19,05, Ø22,22, Ø25,4 and Ø28,58 for material 0. Change to material 1/2H or material H.

**Table 2 - 1 Refrigerant piping size: 2,5 - 14,0 kW type (mm)**

Liquid pipe	Ø6,35				Ø9,52				Ø12,70				
Gas pipe	Ø9,52				Ø12,70				Ø15,88				
PZH3	Type 36 - 60	Additional gas 15 g/m	×	Standard 40 m (30 m)	×	×	×	×	×	×	×	×	×
	Type 25	Additional gas 10 g/m	×	Standard 15 m (7,5 m)	×	×	×	×	×	×	×	×	×
	Type 36	Additional gas 10 g/m	×	Standard 15 m (7,5 m)	×	×	×	×	×	×	×	×	×
PZ3	Type 50	Additional gas 15 g/m	×	Standard 20 m (7,5 m)	×	×	×	×	×	×	×	×	×
	Type 60	Additional gas 15 g/m	×	Standard 30 m (7,5 m)	×	×	×	×	×	×	×	×	×
	Type 71	Additional gas 17 g/m	×	Standard 40 m (10 m)	×	×	×	×	×	×	×	×	×

Liquid pipe	Ø6,35				Ø9,52				Ø12,70				
Gas pipe	Ø9,52				Ø12,70				Ø15,88				
PZH4	Type 71	×	□ 10 m (10 m)	□ 10 m (10 m)	▽ 30 m (30 m)	60 m	⊙	□ 25 m (15 m)	×	□	×	□	×
Additional refrigerant charging amount per 1 m		20 g/m				30 g/m				80 g/m			
PZH4	Type 100 - 140	×	×	×	×	100 m	85 m (30 m)	□ 35 m (15 m)	□ 35 m (15 m)	□	□	□	□
Additional refrigerant charging amount per 1 m		40 g/m				80 g/m				80 g/m			
PZH3	Type 71	×	□ 10 m (10 m)	□ 10 m (10 m)	▽ 30 m (30 m)	Standard 50 m (30 m)	×	□ 25 m (15 m)	×	□	×	□	×
	Type 100 - 140	×	×	×	×	Standard 85 m (30 m)	⊙ 85 m (30 m)	□ 35 m (15 m)	□ 35 m (15 m)	□	□	□	□
Additional gas		20 g/m				45 g/m				80 g/m			
PZ3	Type 100 - 140	×	×	×	×	Standard 50 m (30 m)	⊙ 50 m (30 m)	□ 25 m (15 m)	□ 25 m (15 m)	□	□	□	□

How to see table definition (example):

In case of type 71, standard size is liquid pipe Ø9,52 / gas pipe Ø15,88.  
There is a limitation to liquid pipe Ø9,52 / gas pipe Ø12,70 and to liquid pipe Ø12,70 / gas pipe Ø15,88.  
However, they are applicable for different diameter's pipes.

**Table 2 - 2 Refrigerant piping size: 20,0 - 25,0 kW type (mm)**

Liquid pipe	Ø9,52				Ø12,70				Ø15,88				
Gas pipe	Ø19,05				Ø22,22				Ø25,40				
PZH4	Type 200 - 250	×	×	×	▽ 100 m (30 m)	Standard 100 m (30 m)	⊙ 100 m (30 m)	▽ 65 m (20 m)	□ 65 m (20 m)	□ 65 m (20 m)	□	□	□
Additional refrigerant charging amount per 1 m		80 g/m				80 g/m				120 g/m			

⊙ Allowable □ Limited piping length 50 m Maximum piping length (50 m) Charge less piping length in a single connection  
▽ Cooling capacity down × Unallowable

**Table 3 - Deterioration Criteria for Refrigerant Oil**

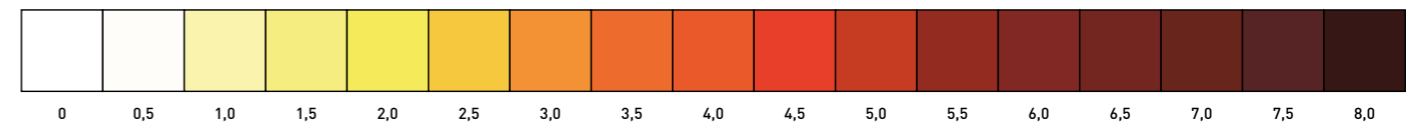

# Accessories and control

## Drain kits

Drain kit to suit outdoor units from 3,6 to 7,1 kW.

-----  
CZ-50DRS1

Drain kit to suit outdoor units from 10,0 to 25,0 kW.

-----  
CZ-140DRS1

## Branch Pipes, Header



Branch pipe.

-----  
CZ-P224BK2BM



Branch pipe (from 22,4 kW to 68,0 kW).

-----  
CZ-P680BK2BM



Header.

-----  
CZ-P3HPC2BM

## Special outdoor supports

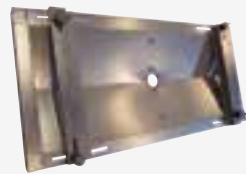

Tray for condenser water compatible with outdoor elevation platform.

-----  
PAW-WTRAY



Outdoor elevation platform.  
Dimension (HxWxD):  
400 x 900 x 400 mm

-----  
PAW-GRDSTD40



Outdoor base ground support for noise and vibration absorption.  
Dimension (HxWxD):  
600 x 95 x 130 mm  
Safe working load: 500 kg

-----  
PAW-GRDBSE20



Black ground stand for outdoor unit with 1100 mm wide condenser water tray.

-----  
PAW-GRDSTD1100

## Panels



**NEW!** Panel for 4 way 60x60 cassette, white (RAL9003).

-----  
CZ-KPY4W



**NEW!** Panel for 4 way 60x60 cassette, graphite black (RAL9011).

-----  
CZ-KPY4B



Standard panel for 4 way 90x90 cassette, white (RAL9003).

-----  
CZ-KPU3



Econavi panel for 4 way 90x90 cassette, white (RAL9003).

-----  
CZ-KPU3A



Standard panel for 4 way 90x90 cassette, graphite black (RAL9011).

-----  
CZ-KPU3B

## Sensors



Econavi energy saving sensor.

-----  
CZ-CENSC1



Remote temperature sensor.

-----  
CZ-CSRC3



Fresh air-intake kit.

-----  
CZ-FDU3+CZ-ATU2

## IAQ filter for adaptive ducted unit



\*Tentative image.

BION air pollutant filter for S-3650PF3E.

-----  
PAW-APF800F

BION air pollutant filter for S-6071PF3E.

-----  
PAW-APF1000F

BION air pollutant filter for S-1014PF3E.

-----  
PAW-APF1400F

## Plenums



Air outlet plenum for S-3650PF3E.

-----  
CZ-56DAF2

Air outlet plenum for S-6071PF3E.

-----  
CZ-90DAF2

Air outlet plenum for S-1014PF3E.

-----  
CZ-160DAF2



Air outlet plenum for S-200PE4E.

-----  
CZ-TREMIESPW705

Air outlet plenum for S-250PE4E.

-----  
CZ-TREMIESPW706

## Controller and touch controllers for hotels with dry contacts



Modbus RS-485 touch room controller with I/O, white.

-----  
PAW-RE2C4-MOD-WH

Touch display control with 2 digital inputs, white.

-----  
PAW-RE2D4-WH



Modbus RS-485 touch room controller with I/O, black.

-----  
PAW-RE2C4-MOD-BK

Touch display control with 2 digital inputs, black.

-----  
PAW-RE2D4-BK

## Hotel sensors for dry contacts



Wall silent motion sensor 24 V.

-----  
PAW-WMS-DC

Wall silent motion sensor 240 V AC.

-----  
PAW-WMS-AC



Ceiling silent motion sensor 24 V.

-----  
PAW-CMS-DC

Ceiling silent motion sensor 240 V AC.

-----  
PAW-CMS-AC



Power supply 24 V.

-----  
PAW-24DC



Door or window contact.

-----  
PAW-DWC

Commercial Smart Edge



Gateway for Commercial Smart Edge – supports up to 4 indoor unit connections.

PAW-CSE-1B

Gateway for Commercial Smart Edge – supports up to 10 indoor unit connections.

PAW-CSE-2B

Gateway for Commercial Smart Edge – supports up to 50 indoor unit connections.

PAW-CSE-10

Gateway for Commercial Smart Edge – supports up to 100 indoor unit connections.

PAW-CSE-20

\*The final number of connected indoor units may vary depending on the range. \*\*For the detail information, please contact an authorised Panasonic dealer.

Centralised controls



System controller for 64 indoor units with weekly timer.

CZ-64ESMC3



Central ON / OFF controller, up to 16 groups, 64 indoor units.

CZ-ANC3



Intelligent controller (touch screen/web server) to control up to 256 indoors with included load distribution ratio (LDR).

CZ-256ESMC3

BMS interface with S-Link



A unified interface supporting Modbus, BACnet, and KNX protocols for up to 16 indoor units.

PAW-AC2-BMS-16

A unified interface supporting Modbus, BACnet, and KNX protocols for up to 64 indoor units.

PAW-AC2-BMS-64

A unified interface supporting Modbus, BACnet, and KNX protocols for up to 128 indoor units.

PAW-AC2-BMS-128

Accessories interfaces



Commercial Wi-Fi Adaptor.

CZ-CAPWFC2



DIN rail-mounted KNX interface.

PAW-RC2-KNX-1i



DIN rail-mounted Modbus RTU interface.

PAW-RC2-MBS-1



Modbus RTU interface to control 4 indoor/groups.

PAW-RC2-MBS-4



BACnet IP and MSTP interface.

PAW-RC2-BAC-1



KNX interface.

PAW-AZRC-KNX-1



Modbus RTU interface with 12 V DC power supply.

PAW-AZRC-MBS-1



BACnet IP and MSTP interface.

PAW-AZRC-BAC-1



RAC interface adapter for integration into S-Link, plus external input and alarm/status output (for YKEA units).

CZ-CAPRA1

Centralised controls. Connection with general equipment



Adaptor for ON / OFF control of external devices. Up to three digital outputs.

CZ-CAPC3



Mini series parallel device controlling indoor units, maximum 1 group and 8 indoor unit.













CZ-CAPBC2



Communication Adaptor. Up to 128 groups. Controls 128 units.

CZ-CFUNC2

Individual controls

 <p><b>CONEX wired remote controller (non-wireless), white.</b></p> <p>----- CZ-RTC6W</p>	 <p><b>CONEX wired remote controller with Bluetooth®, white.</b></p> <p>----- CZ-RTC6WBL</p>	 <p><b>CONEX wired remote controller with Wi-Fi and Bluetooth®, white.</b></p> <p>----- CZ-RTC6WBLW2</p>	 <p><b>CONEX wired remote controller (non-wireless), black.</b></p> <p>----- CZ-RTC6</p>
 <p><b>CONEX wired remote controller with Bluetooth®, black.</b></p> <p>----- CZ-RTC6BL</p>	 <p><b>CONEX wired remote controller with Wi-Fi and Bluetooth®, black.</b></p> <p>----- CZ-RTC6BLW2</p>	 <p><b>Design Wired remote controller with Econavi function.</b></p> <p>----- CZ-RTC5B</p>	 <p><b>Infrared remote controller for wall-mounted.</b></p> <p>----- CZ-RWS3</p>
 <p><b>Infrared remote controller and receiver for 4 way 60x60 cassette with white panel (RAL9003).</b></p> <p>----- CZ-RWS3 + CZ-RWRY3W</p>	 <p><b>Infrared remote controller and receiver for 4 way 90x90 cassette.</b></p> <p>----- CZ-RWS3 + CZ-RWRU3</p>	 <p><b>Infrared remote controller and receiver for ceiling.</b></p> <p>----- CZ-RWS3 + CZ-RWRT3</p>	 <p><b>Infrared remote controller and receiver for all indoor units.</b></p> <p>----- CZ-RWS3 + CZ-RWRC3</p>













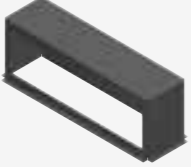
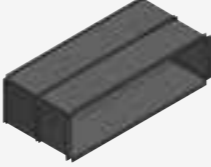

Accessories PCB

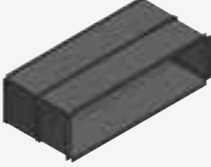
 <p><b>T10 interface PCB with digital and relay connections.</b></p> <p>----- PAW-T10</p>	 <p><b>PCB for server room application, control up to 4 indoor unit groups, redundancy, backup, etc.</b></p> <p>----- PAW-PACR4</p>	 <p><b>Redundancy of 2 units YKEA-1. SG Ready.</b></p> <p>----- PAW-SERVER-PKEA-1</p>
--	--	--

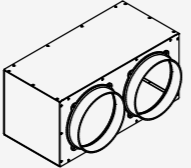
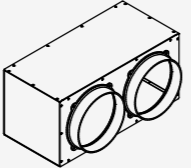
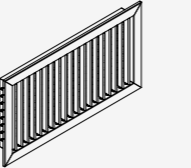
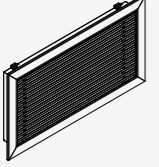
Accessories cables

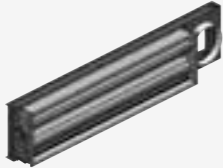
 <p><b>Cable for all the T10 functions.</b></p> <p>----- CZ-T10</p>	 <p><b>Cable to operate external fan.</b></p> <p>----- PAW-FDC</p>	 <p><b>Cable for all option monitoring signals.</b></p> <p>----- PAW-OCT</p>
 <p><b>Cable with force thermo OFF/leakage detection.</b></p> <p>----- PAW-EXCT</p>	 <p><b>Option harness for PAW-OCT and PAW-FDC, providing option, fan drive, and EXCT functions. For PACi NX indoor units PE4 and PK4.</b></p> <p>----- PAW-OPT-MZ</p>	 <p><b>Connector to PACi NX indoor unit's PCB to provide OPT functions.</b></p> <p>----- PAW-OPT-NX</p>

Multi zone duct unit accessories

 <p><b>Wall-mounted control.</b></p> <p>----- PCZ-EEB749</p>	 <p><b>Return plenum with 4 circular inlets DN 160 mm. For S-7110PQ41E.</b></p> <p>----- PCZ-AHRD0468</p>	 <p><b>Return plenum with 5 circular inlets DN 160 mm. For S-1014PQ51E.</b></p> <p>----- PCZ-AHRD0469</p>	 <p><b>Non-return damper.</b></p> <p>----- PCZ-AHRD0519</p>
 <p><b>90° shooting plenum. For S-7110PQ41E.</b></p> <p>----- PCZ-AHRD0524</p>	 <p><b>90° shooting plenum. For S-1014PQ51E.</b></p> <p>----- PCZ-AHRD0525</p>	 <p><b>Telescopic kit for rear or directly coupled suction. 153 mm - 270 mm. For S-7110PQ41E.</b></p> <p>----- PCZ-AHRD0534</p>	 <p><b>Telescopic kit for rear or directly coupled suction. 153 mm - 270 mm. For S-1014PQ51E.</b></p> <p>----- PCZ-AHRD0535</p>
 <p><b>Grille for telescopic kit for rear intake. For S-7110PQ41E.</b></p> <p>----- PCZ-AHRD0544</p>	 <p><b>Grille for telescopic kit for rear intake. For S-1014PQ51E.</b></p> <p>----- PCZ-AHRD0545</p>	 <p><b>Insulated plenum for horizontal or vertical supply/return. For S-7110PQ41E.</b></p> <p>----- PCZ-AHRA0708</p>	 <p><b>White aluminium supply grille with double row of adjustable fins (450 x 225 mm). For S-7110PQ41E.</b></p> <p>----- PCZ-AHRA0709</p>
 <p><b>White aluminium intake grille with removable filter (450 x 225 mm). For S-7110PQ41E.</b></p> <p>----- PCZ-AHRA0710</p>	 <p><b>Replacement recirculation filter kit. For S-7110PQ41E.</b></p> <p>----- PCZ-AHRD0494</p>		 <p><b>Replacement recirculation filter kit. For S-1014PQ51E.</b></p> <p>----- PCZ-AHRD0495</p>
 <p><b>Plenum kit for external air connection with damper for room recirculation. For S-7110PQ41E.</b></p> <p>----- PCZ-AHRD0642</p>	 <p><b>Plenum kit for external air connection with damper for room recirculation. For S-1014PQ51E.</b></p> <p>----- PCZ-AHRD0643</p>	 <p><b>Ducting plate plenum kit for outdoor air connection with damper. For S-7110PQ41E.</b></p> <p>----- PCZ-AHRD0654</p>	 <p><b>Ducting plate plenum kit for outdoor air connection with damper. For S-1014PQ51E.</b></p> <p>----- PCZ-AHRD0655</p>

 <p><b>90° plenum for outdoor air kit with damper. For S-7110PQ41E.</b></p> <p>----- PCZ-AHRD0659</p>	 <p><b>90° plenum for outdoor air kit with damper. For S-1014PQ51E.</b></p> <p>----- PCZ-AHRD0660</p>	 <p><b>Telescopic kit. For plenum for outdoor air kit with damper. For S-7110PQ41E.</b></p> <p>----- PCZ-AHRD0664</p>	 <p><b>Telescopic kit. For plenum for outdoor air kit with damper. For S-1014PQ51E.</b></p> <p>----- PCZ-AHRD0665</p>
--	--	--	--

 <p><b>Grille for telescopic kit. For plenum for outdoor air kit with damper. For S-7110PQ41E.</b></p> <p>----- PCZ-AHRD0669</p>	 <p><b>Grille for telescopic kit. For plenum for outdoor air kit with damper. For S-1014PQ51E.</b></p> <p>----- PCZ-AHRD0670</p>
---	---

Accessories for Jet Air Stream +

 <p><b>Ducted air intake plenum (1 x DN 355 mm) for VTVF140.</b></p> <p>----- PCZ-AHRX0056</p>	 <p><b>Ducted air intake plenum (2 x DN 355 mm) for VTVF250.</b></p> <p>----- PCZ-AHRX0057</p>	 <p><b>Ground air intake module (VTVF250 requires two of them).</b></p> <p>----- PCZ-AHRX0061</p>	 <p><b>Air supply grille for ducts.</b></p> <p>----- PCZ-AHRX0071</p>
---	---	--	--

## Eurovent certified technical data

Panasonic's PACi NX and VRF systems are now certified by Eurovent\*. The Eurovent certification verifies the performance ratings of heating and cooling systems following European standards. Data provides products efficiency with full transparency, for the benefit of customers and professionals.



### Commercial air to air - PACi NX

#### Eurovent AC1 certified technical data: PACi NX Series Elite wall-mounted - PK4 - R32

Outdoor unit		U-36PZH3E5	U-50PZH3E5	U-60PZH3E5	U-71PZH4E5	U-71PZH4E8	U-100PZH4E5	U-100PZH4E8	
Indoor unit		S-2545PK4E	S-5010PK4E	S-5010PK4E	S-5010PK4E	S-5010PK4E	S-5010PK4E	S-5010PK4E	
Seasonal efficiency in cooling (SEASC)	Pdesign	kW	3,50	5,00	6,10	7,10	7,10	9,50	9,50
	SEER		7,70	8,00	7,10	6,60	6,60	6,60	6,60
	Qce	kWh/annum	160,00	219,00	301,00	377,00	377,00	504,00	504,00
Standard cooling PL Condition A (STD cooling)	Nominal cooling capacity (Pc)	kW	3,50	5,00	6,10	7,10	7,10	9,50	9,50
	Input power (Pec)	kW	0,79	1,22	1,63	1,89	1,89	2,79	2,79
	EER		4,43	4,10	3,74	3,76	3,76	3,41	3,41
Heating average climate (SEASHAvg)	Pdesign	kW	3,10	4,50	4,60	5,20	5,20	8,00	8,00
	SCOP		4,70	4,60	4,70	4,60	4,60	4,10	4,10
	Qhe	kWh/annum	924,00	1369,00	1370,00	1583,00	1583,00	2731,00	2731,00
Standard heating (STD heating)	Nominal heating capacity (Ph)	kW	4,00	5,60	7,00	7,80	7,80	9,50	9,50
	Input power (Peh)	kW	0,94	1,39	1,70	1,95	1,95	2,44	2,44
	COP		4,26	4,03	4,12	4,00	4,00	3,89	3,89
Acoustic (sound)	Lw0 env	dB(A)	62	64	65	65	65	69	69

#### Eurovent AC1 certified technical data: PACi NX Series Elite 4 way 60x60 cassette - PY3 - R32

Outdoor unit		U-36PZH3E5	U-50PZH3E5	U-60PZH3E5	
Indoor unit		S-36PY3E	S-50PY3E	S-60PY3E	
Seasonal efficiency in cooling (SEASC)	Pdesign	kW	3,60	4,7	6,00
	SEER		7,30	7,00	6,70
	Qce	kWh/annum	171,00	235	314,00
Standard cooling PL Condition A (STD cooling)	Nominal cooling capacity (Pc)	kW	3,60	4,7	6,00
	Input power (Pec)	kW	0,80	1,25	1,75
	EER		4,50	3,76	3,43
Heating average climate (SEASHAvg)	Pdesign	kW	3,60	4,50	4,60
	SCOP		4,70	4,60	4,30
	Qhe	kWh/annum	1073,00	1370,00	1498,00
Standard heating (STD heating)	Nominal heating capacity (Ph)	kW	4,00	5,60	7,00
	Input power (Peh)	kW	0,97	1,66	2,06
	COP		4,12	3,37	3,40
Acoustic (sound)	Lw0 env	dB(A)	62	64	65

#### Eurovent AC1 certified technical data: PACi NX Series Elite 4 way 90x90 cassette - PU3 - R32

Outdoor unit		U-36PZH3E5	U-50PZH3E5	U-60PZH3E5	U-71PZH4E5	U-71PZH4E8	U-100PZH4E5	U-100PZH4E8	
Indoor unit		S-3650PU3E	S-3650PU3E	S-6071PU3E	S-6071PU3E	S-6071PU3E	S-1014PU3E	S-1014PU3E	
Seasonal efficiency in cooling (SEASC)	Pdesign	kW	3,60	5,00	6,00	7,10	7,10	9,50	9,50
	SEER		8,90	8,60	8,00	7,70	7,70	7,80	7,80
	Qce	kWh/annum	142,00	203,00	263,00	323,00	323,00	426,00	426,00
Standard cooling PL Condition A (STD cooling)	Nominal cooling capacity (Pc)	kW	3,60	5,00	6,00	7,10	7,10	9,50	9,50
	Input power (Pec)	kW	0,66	1,16	1,48	1,75	1,75	2,15	2,15
	EER		5,45	4,31	4,05	4,06	4,06	4,42	4,42
Heating average climate (SEASHAvg)	Pdesign	kW	3,60	4,50	4,70	5,20	5,20	8,00	8,00
	SCOP		5,10	4,90	4,80	4,80	4,80	4,90	4,90
	Qhe	kWh/annum	988,00	1286,00	1371,00	1517,00	1517,00	2286,00	2286,00
Standard heating (STD heating)	Nominal heating capacity (Ph)	kW	4,00	5,60	7,00	8,00	8,00	11,20	11,20
	Input power (Peh)	kW	0,74	1,32	1,74	1,86	1,86	2,24	2,24
	COP		5,41	4,24	4,02	4,30	4,30	5,00	5,00
Acoustic (sound)	Lw0 env	dB(A)	62	64	65	65	65	69	69

#### Eurovent AC1 certified technical data: PACi NX Series Elite ceiling - PT3 - R32

Outdoor unit		U-36PZH3E5	U-50PZH3E5	U-60PZH3E5	U-71PZH4E5	U-71PZH4E8	U-100PZH4E5	U-100PZH4E8	
Indoor unit		S-3650PT3E	S-3650PT3E	S-6071PT3E	S-6071PT3E	S-6071PT3E	S-1014PT3E	S-1014PT3E	
Seasonal efficiency in cooling (SEASC)	Pdesign	kW	3,50	5,00	6,00	6,80	6,80	9,50	9,50
	SEER		7,70	7,40	7,50	7,30	7,20	7,30	7,20
	Qce	kWh/annum	160,00	237,00	280,00	326,00	331,00	456,00	462,00
Standard cooling PL Condition A (STD cooling)	Nominal cooling capacity (Pc)	kW	3,50	5,00	6,00	6,80	6,80	9,50	9,50
	Input power (Pec)	kW	0,72	1,24	1,57	1,74	1,74	2,34	2,34
	EER		4,86	4,03	3,82	3,91	3,91	4,06	4,06
Heating average climate (SEASHAvg)	Pdesign	kW	3,10	4,00	4,60	4,70	4,70	7,80	7,80
	SCOP		4,90	4,80	4,80	4,70	4,70	4,50	4,50
	Qhe	kWh/annum	886,00	1167,00	1342,00	1400,00	1400,00	2426,00	2427,00
Standard heating (STD heating)	Nominal heating capacity (Ph)	kW	4,00	5,60	7,00	8,00	8,00	11,20	11,20
	Input power (Peh)	kW	0,80	1,39	1,69	2,02	2,02	2,80	2,80
	COP		5,00	4,03	4,14	3,96	3,96	4,00	4,00
Acoustic (sound)	Lw0 env	dB(A)	62	64	65	65	65	69	69

#### Eurovent AC1 certified technical data: PACi NX Series Elite adaptive ducted unit - PF3 - R32

Outdoor unit		U-36PZH3E5	U-50PZH3E5	U-60PZH3E5	U-71PZH4E5	U-71PZH4E8	U-100PZH4E5	U-100PZH4E8	
Indoor unit		S-3650PF3E	S-3650PF3E	S-6071PF3E	S-6071PF3E	S-6071PF3E	S-1014PF3E	S-1014PF3E	
Seasonal efficiency in cooling (SEASC)	Pdesign	kW	3,60	5,00	5,70	6,80	6,80	9,50	9,50
	SEER		6,80	6,10	7,10	7,10	7,10	7,40	7,40
	Qce	kWh/annum	185,00	287,00	281,00	332,00	332,00	447,00	447,00
Standard cooling PL Condition A (STD cooling)	Nominal cooling capacity (Pc)	kW	3,60	5,00	5,70	6,80	6,80	9,50	9,50
	Input power (Pec)	kW	0,85	1,46	1,55	1,82	1,82	2,32	2,32
	EER		4,24	3,42	3,68	3,74	3,74	4,09	4,09
Heating average climate (SEASHAvg)	Pdesign	kW	3,60	4,00	4,70	4,70	4,70	7,80	7,80
	SCOP		4,50	4,20	4,40	4,70	4,70	4,30	4,30
	Qhe	kWh/annum	1120,00	1333,00	1495,00	1393,00	1394,00	2540,00	2540,00
Standard heating (STD heating)	Nominal heating capacity (Ph)	kW	4,00	5,60	7,00	7,50	7,50	10,80	10,80
	Input power (Peh)	kW	0,96	1,55	1,87	1,86	1,86	2,78	2,78
	COP		4,17	3,61	3,74	4,03	4,03	3,88	3,88
Acoustic (sound)	Lw0 env	dB(A)	62	64	65	65	65	69	69

#### Eurovent AC2 certified technical data: Big PACi NX Elite high static pressure hide-away - PE4 - R32

Outdoor unit		U-200PZH4E8	U-250PZH4E8	
Indoor unit		S-200PE4E	S-250PE4E	
Seasonal efficiency in cooling (SEASC)	Pdesign	kW	19,00	22,00
	SEER		6,02	5,40
	Qce	kWh/annum	237,80	213,00
Standard cooling PL Condition A (STD cooling)	Nominal cooling capacity (Pc)	kW	19,00	22,00
	Input power (Pec)	kW	5,93	8,04
	EER		3,20	2,74
Heating average climate (SEASHAvg)	Pdesign	kW	14,50	15,00
	SCOP		3,85	3,83
	Qhe	kWh/annum	151,10	150,20
Standard heating (STD heating)	Nominal heating capacity (Ph)	kW	22,40	24,00
	Input power (Peh)	kW	6,31	6,76
	COP		3,55	3,55
Acoustic (sound)	Lw0 env	dB(A)	—	—

## Eurovent certified technical data



## Commercial air to air - PACi NX

## Eurovent AC1 certified technical data: PACi NX Series Standard wall-mounted - PK4 · R32

Outdoor unit		U-25PZ3E5	U-36PZ3E5	U-50PZ3E5	U-60PZ3E5A	U-71PZ3E5A	U-100PZ3E5	U-100PZ3E8
Indoor unit		S-2545PK4E	S-2545PK4E	S-5010PK4E	S-5010PK4E	S-5010PK4E	S-5010PK4E	S-5010PK4E
Seasonal efficiency in cooling (SEASC)	Pdesign	kW	2,50	3,50	5,00	6,10	6,90	9,00
	SEER		6,60	6,80	7,20	7,00	6,00	6,20
	Qce	kWh/annum	133,00	181,00	243,00	305,00	402,00	508,00
Standard cooling PL Condition A (STD cooling)	Nominal cooling capacity (Pc)	kW	2,50	3,50	5,00	6,10	6,90	9,00
	Input power (Pec)	kW	0,57	0,90	1,47	1,71	2,10	2,79
	EER		4,39	3,89	3,40	3,57	3,29	3,23
Heating average climate (SEASHAvg)	Pdesign	kW	2,50	2,60	4,00	4,60	5,20	8,80
	SCOP		4,20	4,40	4,40	4,60	4,40	4,00
	Qhe	kWh/annum	833,00	827,00	1271,00	1400,00	1654,00	3080,00
Standard heating (STD heating)	Nominal heating capacity (Ph)	kW	2,80	3,60	5,00	6,10	7,10	9,00
	Input power (Peh)	kW	0,62	0,88	1,19	1,43	1,73	2,36
	COP		4,52	4,09	4,20	4,27	4,10	3,81
Acoustic (sound)	Lw0 env	dB(A)	64	64	64	64	66	70

## Eurovent AC1 certified technical data: PACi NX Series Standard 4 way 60x60 cassette - PY3 · R32

Outdoor unit		U-25PZ3E5	U-36PZ3E5	U-50PZ3E5	U-60PZ3E5A
Indoor unit		S-25PY3E	S-36PY3E	S-50PY3E	S-60PY3E
Seasonal efficiency in cooling (SEASC)	Pdesign	kW	2,50	3,60	4,7
	SEER		6,50	6,70	7,30
	Qce	kWh/annum	134,00	188,00	226
Standard cooling PL Condition A (STD cooling)	Nominal cooling capacity (Pc)	kW	2,50	3,60	4,7
	Input power (Pec)	kW	0,56	0,91	1,34
	EER		4,46	3,96	3,51
Heating average climate (SEASHAvg)	Pdesign	kW	2,80	2,80	4,00
	SCOP		4,60	4,30	4,40
	Qhe	kWh/annum	850,00	912,00	1264,00
Standard heating (STD heating)	Nominal heating capacity (Ph)	kW	3,20	3,60	5,00
	Input power (Peh)	kW	0,72	0,84	1,27
	COP		4,44	4,29	3,94
Acoustic (sound)	Lw0 env	dB(A)	64	64	64

## Eurovent AC1 certified technical data: PACi NX Series Standard 4 way 90x90 cassette - PU3 · R32

Outdoor unit		U-36PZ3E5	U-50PZ3E5	U-60PZ3E5A	U-71PZ3E5A	U-100PZ3E5	U-100PZ3E8
Indoor unit		S-3650PU3E	S-3650PU3E	S-6071PU3E	S-6071PU3E	S-1014PU3E	S-1014PU3E
Seasonal efficiency in cooling (SEASC)	Pdesign	kW	3,60	5,00	6,00	7,10	10,00
	SEER		8,10	8,00	7,80	6,80	6,70
	Qce	kWh/annum	156,00	219,00	269,00	365,00	515,00
Standard cooling PL Condition A (STD cooling)	Nominal cooling capacity (Pc)	kW	3,60	5,00	6,00	7,10	10,00
	Input power (Pec)	kW	0,83	1,28	1,61	2,17	2,62
	EER		4,34	3,91	3,73	3,27	3,82
Heating average climate (SEASHAvg)	Pdesign	kW	2,80	4,00	4,60	5,20	10,00
	SCOP		4,80	4,70	4,90	4,60	4,40
	Qhe	kWh/annum	817,00	1191,00	1314,00	1583,00	3182,00
Standard heating (STD heating)	Nominal heating capacity (Ph)	kW	3,60	5,00	6,00	7,10	10,00
	Input power (Peh)	kW	0,71	1,08	1,34	1,68	2,03
	COP		5,07	4,63	4,48	4,23	4,93
Acoustic (sound)	Lw0 env	dB(A)	64	64	64	66	70

## Eurovent AC1 certified technical data: PACi NX Series Standard ceiling - PT3 · R32

Outdoor unit		U-36PZ3E5	U-50PZ3E5	U-60PZ3E5A	U-71PZ3E5A	U-100PZ3E5	U-100PZ3E8
Indoor unit		S-3650PT3E	S-3650PT3E	S-6071PT3E	S-6071PT3E	S-1014PT3E	S-1014PT3E
Seasonal efficiency in cooling (SEASC)	Pdesign	kW	3,50	5,00	6,00	6,80	10,00
	SEER		7,20	6,70	7,30	5,90	6,60
	Qce	kWh/annum	171,00	262,00	288,00	404,00	531,00
Standard cooling PL Condition A (STD cooling)	Nominal cooling capacity (Pc)	kW	3,50	5,00	6,00	6,80	10,00
	Input power (Pec)	kW	0,85	1,65	1,67	2,10	2,75
	EER		4,14	3,03	3,59	3,24	3,64
Heating average climate (SEASHAvg)	Pdesign	kW	2,80	4,00	4,60	4,70	10,00
	SCOP		4,40	4,10	4,60	4,30	4,20
	Qhe	kWh/annum	891,00	1365,00	1399,00	1529,00	3331,00
Standard heating (STD heating)	Nominal heating capacity (Ph)	kW	3,50	5,00	6,00	6,80	10,00
	Input power (Peh)	kW	0,76	1,34	1,46	1,62	2,36
	COP		4,61	3,73	4,11	4,20	4,24
Acoustic (sound)	Lw0 env	dB(A)	64	64	64	66	70

## Eurovent AC1 certified technical data: PACi NX Series Standard adaptive ducted unit - PF3 · R32

Outdoor unit		U-36PZ3E5	U-50PZ3E5	U-60PZ3E5A	U-71PZ3E5A	U-100PZ3E5	U-100PZ3E8
Indoor unit		S-3650PF3E	S-3650PF3E	S-6071PF3E	S-6071PF3E	S-1014PF3E	S-1014PF3E
Seasonal efficiency in cooling (SEASC)	Pdesign	kW	3,40	5,00	5,70	6,80	9,50
	SEER		6,00	6,50	6,40	6,00	6,60
	Qce	kWh/annum	198,00	267,00	310,00	391,00	502,00
Standard cooling PL Condition A (STD cooling)	Nominal cooling capacity (Pc)	kW	3,40	5,00	5,70	6,80	9,50
	Input power (Pec)	kW	0,90	1,80	1,61	2,14	2,66
	EER		3,78	2,78	3,54	3,18	3,57
Heating average climate (SEASHAvg)	Pdesign	kW	2,40	3,80	4,40	4,70	7,80
	SCOP		4,00	4,00	4,40	4,10	3,90
	Qhe	kWh/annum	839,00	1303,00	1376,00	1591,00	2795,00
Standard heating (STD heating)	Nominal heating capacity (Ph)	kW	3,40	5,00	5,70	6,80	9,50
	Input power (Peh)	kW	0,82	1,38	1,41	1,70	2,32
	COP		4,15	3,62	4,04	4,00	4,09
Acoustic (sound)	Lw0 env	dB(A)	64	64	64	66	70

## Wall-mounted Professional YKEA





## Eurovent AC1 certified technical data: Wall-mounted Professional YKEA · R32

Kit		KIT-Z25-YKEA-1	KIT-Z35-YKEA-1	KIT-Z42-YKEA-1	KIT-Z50-YKEA-1	KIT-Z71-YKEA-1
Outdoor unit		CU-Z25YKEA-1	CU-Z35YKEA-1	CU-Z42YKEA-1	CU-Z50YKEA-1	CU-Z71YKEA-1
Indoor unit		CS-Z25YKEA-1	CS-Z35YKEA-1	CS-Z42YKEA-1	CS-Z50YKEA-1	CS-Z71YKEA-1
Seasonal efficiency in cooling (SEASC)	Pdesign	kW	2,50	3,50	4,20	4,70
	SEER		9,50	9,60	8,60	8,60
	Qce	kWh/annum	92,00	128,00	171,00	191
Standard cooling PL Condition A (STD cooling)	Nominal cooling capacity (Pc)	kW	2,50	3,50	4,20	4,70
	Input power (Pec)	kW	0,51	0,85	1,10	1,12
	EER		4,90	4,12	3,82	4,20
Heating average climate (SEASHAvg)	Pdesign	kW	2,70	3,20	3,60	4,20
	SCOP		4,60	4,60	4,50	4,60
	Qhe	kWh/annum	822,00	974,00	1120,00	1278,00
Standard heating (STD heating)	Nominal heating capacity (Ph)	kW	3,40	4,00	5,30	5,80
	Input power (Peh)	kW	0,70	0,90	1,35	1,42
	COP		4,86	4,44	3,93	4,08
Acoustic (sound)	Lw0 env	dB(A)	61	63	64	63













## Features explained

### Energy saving.





- 
**REFRIGERANT R32.** Our heat pumps containing R32 refrigerant show a drastic reduction in the value of Global Warming Potential (GWP).
- 
**EXCEPTIONAL SEASONAL COOLING EFFICIENCY BASED ON THE ERP REGULATION.** Higher SEER ratings mean greater efficiency and year-round cooling savings!
- 
**EXCEPTIONAL SEASONAL HEATING EFFICIENCY BASED ON THE ERP REGULATION.** Higher SCOP ratings mean greater efficiency and year-round heating savings!
- 
**ECONAVI.** Intelligent human activity sensor and sunlight sensor technologies that can detect and reduces the waste of energy by optimising air conditioner operation according to room conditions. With just one touch of a button, you can save energy.
- 
**INVERTER PLUS SYSTEM.** Inverter Plus system classification highlights Panasonic's highest performing systems.

- 
**INVERTER.** The Inverter range provides greater efficiency and comfort. Provides more precise temperature control, without highs and lows, and keeps the ambient temperature constant with lower energy consumption and a significant reduction in noise and vibration levels.
- 
**HIGH-EFFICIENCY COMPRESSOR.** Panasonic Big PACi NX Elite has compressors that operate with a wider Hz range realize a more efficient operation throughout the year.
- 
**PANASONIC R2 ROTARY COMPRESSOR.** Designed to withstand extreme conditions, it delivers high performance and efficiency.
- 
**BETTER EFFICIENCY AND VALUE FOR LOW TEMPERATURE APPLICATIONS.** On an energy efficiency scale from D to A+++, the PACi NX Water Heat Exchanger provide A+++ rated heating.

### High performance and indoor air quality.

- 
**DOWN TO -20 °C IN COOLING MODE.** The air conditioner works in cooling mode when the outdoor temperature of -20 °C.
- 
**DOWN TO -20 °C IN HEATING MODE.** The air conditioner works in heat pump mode when the outdoor temperature is as low as -20 °C.
- 
**nanoe™ X.** Technology with the benefits of hydroxyl radicals has the capacity to inhibit pollutants, viruses, and bacteria to clean and deodorise.
- 
**SUPER QUIET.** With Super Quiet technology our devices are quieter than a library (30 dB(A)).
- 
**DC FAN.** Safe and precise.
- 
**FILTER INCLUDED.** Hide-away with filter included.
- 
**BLUEFIN.** Panasonic Big PACi NX Elite has extended the life of its condensers with an original anti-rust coating.
- 
**LARGE FAN.** Panasonic Big PACi NX Elite large fan provides larger air flow rate and very quiet operation at low speed.
- 
**MORE COMFORT WITH AEROWINGS.** Panasonic's Aerowings feature incorporates two blades that concentrate the air flow to cool or heat in the shortest possible time by distributing the air evenly throughout the room. For wall-mounted YKEA.
- 
**UP TO 52 °C IN COOLING MODE.** PACi NX with Water Heat Exchanger system works in cooling mode at outdoor temperature up to 52 °C.
- 
**R410A/R22 RENEWAL.** The Panasonic renewal system allows good quality existing R410A or R22 pipe work to be re-used whilst installing high-efficiency R32 systems.
- 
**5 YEARS COMPRESSOR WARRANTY.** We guarantee the outdoor unit compressors in the entire range for five years.

### High connectivity.

- 
**COMMERCIAL SMART EDGE.** Manage the entire Panasonic HVAC portfolio from a single platform – on-site or remotely, 24/7. Simplified commissioning, optimised plant management, and advanced analytics.
- 
**INTERNET CONTROL.** A next generation system providing user-friendly control of air conditioning or heat pump units from everywhere, using a simple Android™ or iOS smartphone or tablet via Wi-Fi.
- 
**BMS CONNECTIVITY.** The communication port can be integrated into the indoor unit and provides easy connection to, and control of, your Panasonic air conditioner to your home or Building Management System.
- 
**DOMESTIC INTEGRATION TO S-LINK - CZ-CAPRA1.** Can connect RAC range to S-Link. Full control is now possible.
- 
**ADVANCED CONTROL.** A touch screen remote controller is included as a standard. Clean design, easy operation and quick access to all menus.

